

Number Prefix	Product Group	Page Number
SV10	Speculums & Retractors	3
SV20	Knives, Spuds, Blade Breakers, Punches & Handles	10
SV30	Lasik/Lasek/Dalk, Curettes, Spatulas, Choppers Manipulators, Loops, Spoons, Hooks, Fixations Rings Muscle Hooks, Corneal Markers & Calipers	13
SV40	Scissors	43
SV50	Forceps	55
SV60	Needle Holders	97
SV70	Lacrimal Instruments, Quickswitch I/A System Infusion Handles Bimanual Hand Pieces, Rongeurs, Nasal Speculums, Elevators, Chisels, Mallets & Probes	103
SV80	Bipolar Forceps	110
SV90	Sterilization Cases & Trays	111

SV10

- Speculums
- Retractors

SV20

- Knives
- Spuds
- Blade Breakers
- Punches
- Handles

Barraquer Wire Speculums

- SV10-5000 standard wire 0.8mm, 10mm blades
- SV10-5009 heavy wire 1mm, 15mm blades
- SV10-5010 standard wire 0.8mm, 15mm blades

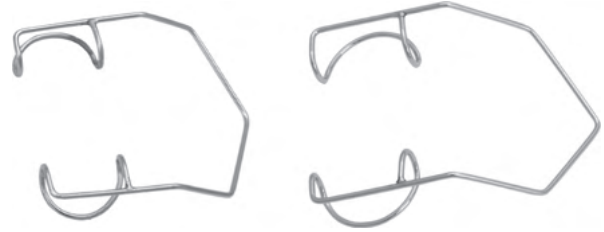

Barraquer Wire Speculums

- Wire Speculum
- SV10-5355 10mm blades (infant)
 - SV10-5356 15mm blades

- Grandon-Barraquer
- SV10-5011 15mm blades

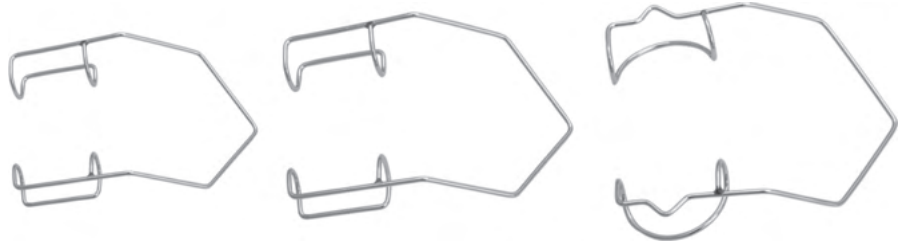

Temporal Approach

- Wire Speculum
with spring on nasal side
- SV10-5012 15mm closed blades
 - SV10-5015 15mm open blades

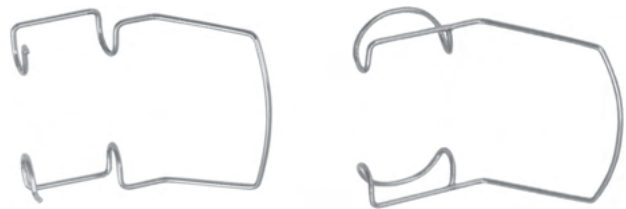

Kratz-Barraquer

- Wire Speculum
with open blades
- For unobstructed access to the
cataract incision with phaco or I/A tip.

- SV10-5049 heavy wire 1mm, 15 mm blades
- SV10-5050 standard wire 0.8mm, 15mm blades
- SV10-5051 standard wire 0.8mm, 13mm blades
- SV10-18005/A standard wire 0.8mm, 15mm blades
- SV10-18005/B heavy wire 1mm, 15 mm blades

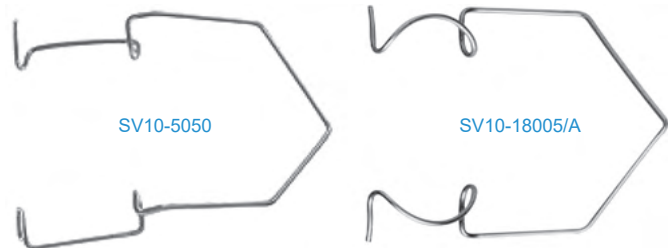

Barraquer Solid Blade

- Wire Speculum
- SV10-5020 Barraquer, 10mm blades
 - SV10-5030 Barraquer, 15mm blades
 - SV10-5031 Feaster, 20mm blades

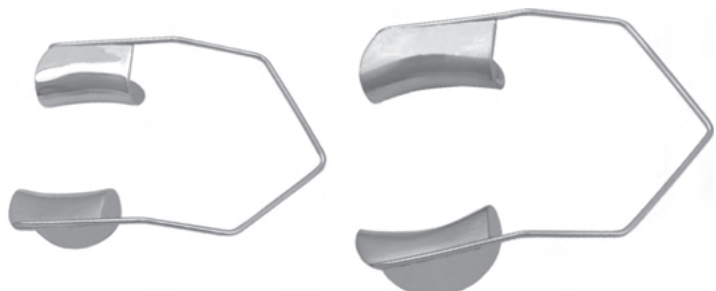

Speculums

Sauer

Lid Speculum

[SV10-5300](#)

for infants, 11mm blades

[SV10-5302](#)

for premature infants, 2mm blades

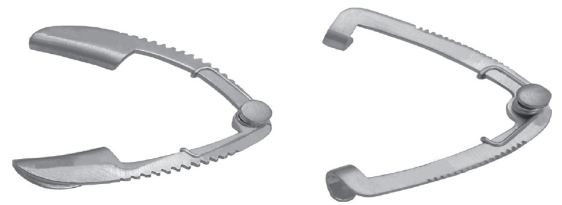

Infant Wire Speculum

[SV10-5320](#) Blades size 5mm, Open

[SV10-5325](#) Blades size 5mm, Close

[SV10-5330](#) Blades size 6mm, Solid

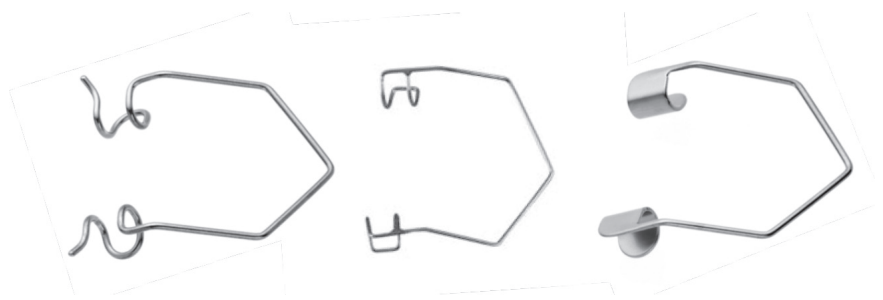

Alphonso

Infant Lid Speculum finger grips and interlacing blades to facilitate insertion one blade 5mm, one blade 7mm

[SV10-5340](#)

Infant Lid Speculum

Lid Speculum closed wire blades gently curved spring

[SV10-5350](#) 4mm blades

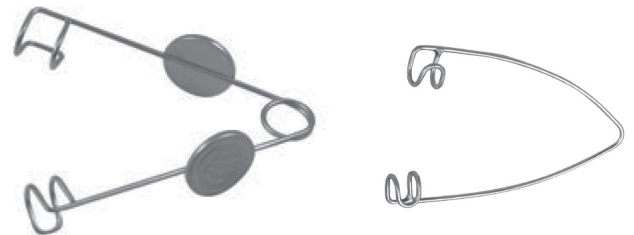

Murdoch

Eye Speculum with locking screw

[SV10-5406](#) #2, 12mm blades

[SV10-5407](#) #3, 15mm blades

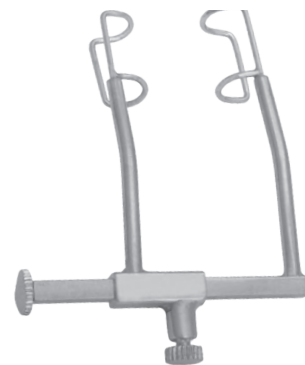

Mellinger

Eye Speculum self retaining for unobstructed access to the cataract incision with phaco or I/A tip.

[SV10-5411](#) 15mm blades



Lester - Burch Speculum

Eye Speculum with flanges on blades for retaining eye lashes
adjustable mechanism
with locking screw
SV10-5620



Lieberman Speculum

adjustable mechanism

- SV10-5665 Lieberman, K-wire, 5mm blades, infant
- SV10-5670 Lieberman, K-wire, 10mm blades, small
- SV10-5671 Lieberman, K-wire, 15mm blades, standard
- SV10-5675 Lieberman, V-shaped, 15mm blades
- SV10-5668 Tanna-Lieberman, 15mm blades
- SV10-5673 Thorlakson, rounded, 13mm blades
- SV10-5674 Lieberman, triple post, 13mm blades
- SV10-5671T **Titanium 15mm K-wire, blades**
- SV10-5675T **Titanium 15mm W-wire, blades**
- SV10-5673T **Titanium rounded, 13mm blades**

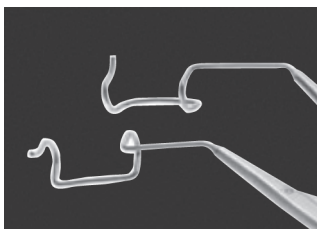

SV10-5670

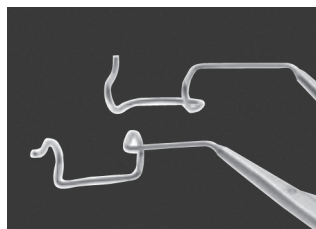

SV10-5671

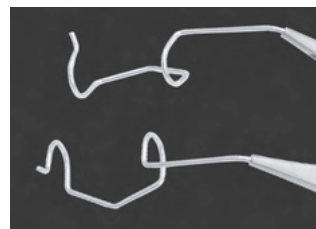

SV10-5675

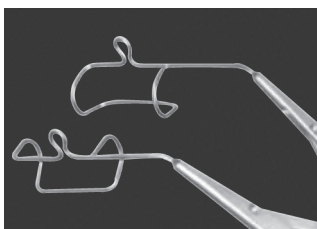

SV10-5668

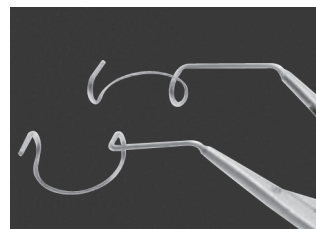

SV10-5673

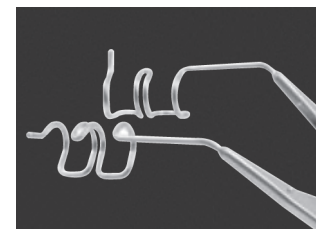

SV10-5674

Speculums

Lieberman Speculum

Eye Speculum

Adjustable mechanism

non-reflective finish

[SV10-5666](#) 5mm blades, Infant

[SV10-5677](#) 10mm blades, Small

[SV10-5678](#) 15mm blades, Standard



Jaffe

Wire Lid Retractor

[SV10-8000](#) pair, 15mm blades (large)

[SV10-8001](#) pair, 13mm blades (small)



Lieberman Style, aspirating

adjustable mechanism

Features aspirating ports to remove
excess fluid from the surgical field.

Supplied with silicone tubing and
luer-lock adaptor.

[SV10-5171](#) Lieberman, Kratz style, 15mm blades

[SV10-5173](#) Thorlakson, rounded, 11mm blades

[SV10-5175](#) Lieberman, V-shaped, 15mm blades

[SV10-5180](#) Chu, solid, reversible, 15mm blades

[SV10-5179](#) Replacement silicone tubing, 100cm (39")

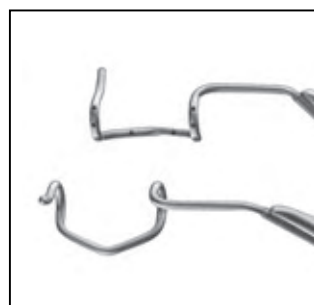
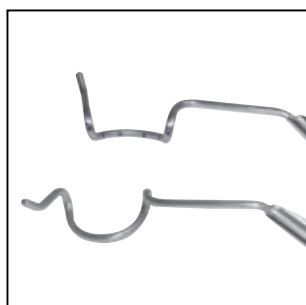

Flieringa

Scleral Fixation Ring

[SV10-7100](#) set of eight, 15mm-22mm

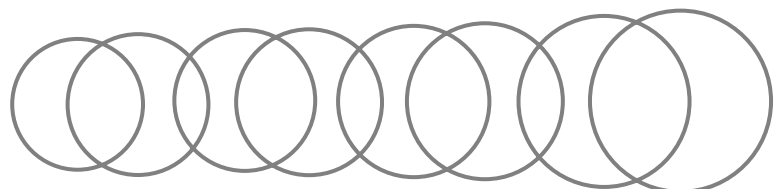

Schocket

Scleral Depressor double-end
with pocket clip 6mm wide bar
and 2.5mm tear drop

[SV10-7825](#)
[SV10-7822](#)



Schepens

Orbital Retractor

[SV10-7880](#)



Jaffe

Wire Lid Retractor

[SV10-8000](#) pair, 15mm blades (large)

[SV10-8001](#) pair, 13mm blades (small)



Senn

Senn Miller Lid Retractor

[SV10-8100](#)

Sharp, 7x8mm, 16 cm 6¼"

[SV10-8120](#)

Blunt, 7x8mm, 16 cm 6¼"



Senn

Senn Miller Lid Retractor, Double Ended

[SV10-8150](#) Sharp

[SV10-8160](#) Blunt



Desmarres

Lid Retractor

thin solid blades

[SV10-8200](#)

size 0, 11mm wide

[SV10-8210](#)

size 1, 13mm wide

[SV10-8220](#)

size 2, 15mm wide

[SV10-8230](#)

size 3, 17mm wide

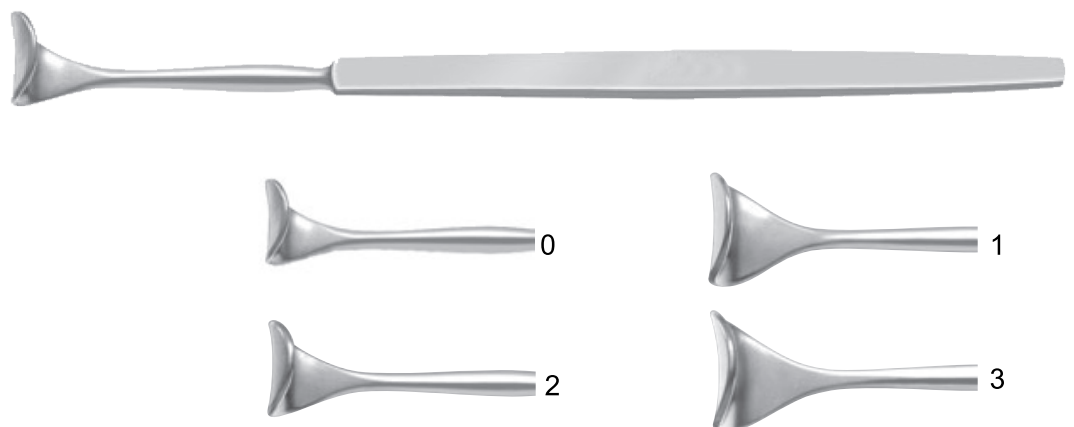

Retractors

Jaeger

Lid Plate

SV10-8500 stainless steel, Small

SV10-8510 stainless steel, Large



Wright

Fascia Needle

1mm x 6mm oval hole

140mm long

SV10-8540



Knapp

Lacrimal Retractor

4 prongs

SV10-9000 blunt

SV10-9001 sharp



Rollet

Rollet retractor

SV10-9002 4-blunt

SV10-9003 3-blunt



Helveston

Tissue Retractor

thin curved blade

SV10-9010

"Barbie" 7mm wide

SV10-9012

"Big Barbie" 9mm wide

SV10-9019

"Great Big Barbie"

11mm wide concave blade



Punches

Gass

Corneoscleral Punch
1.5mm diameter head
0.75mm deep bite
rotatable tip for
convenient positioning
[SV20-9500](#)



Kelly

Descemet's Membrane Punch
1.0mm diameter head
0.75mm deep bite
[SV20-9510](#)

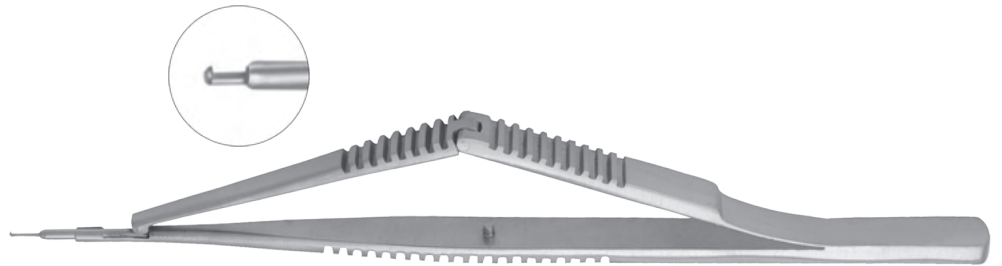

Fukasaku

Micro Trabeculectomy Punch
0.6mm diameter head
with bullet shaped tip
0.3mm x 0.6mm deep bite
[SV20-9512](#)

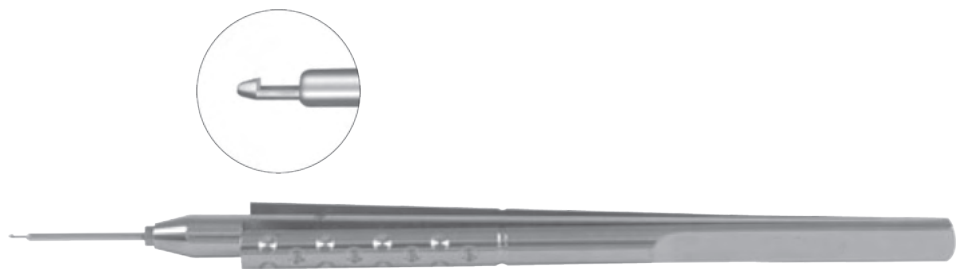

Christensen

Punctum Punch
1mm wide bite
for opening stenotic punctums.
[SV20-9525](#)

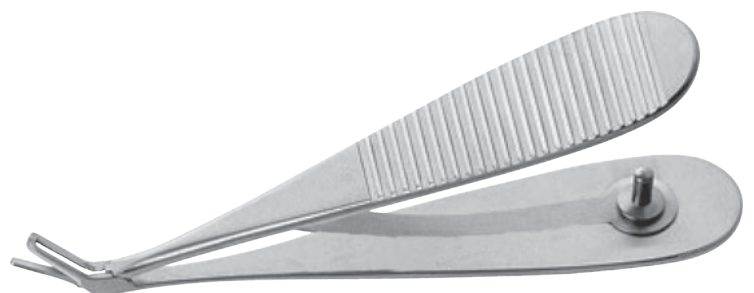

SV30

- Curettes
- Spatulas / Choppers
- Manipulators / Loops
- Loops / Spoons / Manipulators
- Hooks / Manipulators
- Fixation Rings
- Muscle Hooks
- Corneal Markers
- Calipers

Meyerhoefer

Chalazion Curette

- SV30-1000 size 0, 1.5mm dia.
- SV30-1010 size 1, 1.75mm dia.
- SV30-1020 size 2, 2.25mm dia.
- SV30-1030 size 3, 2.5mm dia.
- SV30-1040 size 4, 3.5mm dia.



Double End Curette

- SV30-1041 size 1.5mm / 2.5mm dia.
- SV30-1042 size 2mm / 3mm dia.
- SV30-1043 size 2.5mm / 3.5mm dia.



Capsule

Polishing Curette

1.75mm diameter open ring

- SV30-1100 Nightingale, semi-sharp, posterior edge
- SV30-1102 Shepherd, semi-sharp, anterior and posterior edges

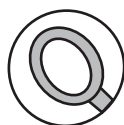

Culler

Iris Spatula

- SV30-2100 1mm wide
- SV30-2110 2mm wide
- SV30-2111 nettleship iris reposer



Wheeler

Double-End Spatula

lightly curved

SV30-2120



Barraquer

Iris Spatula

round, smooth

- SV30-2300 0.5mm diameter
- SV30-2310 0.25mm diameter



Lasik / Lasek / Dalk

Buratto

LASIK Flap Protector
For retracting and
protecting nasally hinged
corneal flaps.
[SV30-1770](#)



Buratto

LASIK Flap Protector
blades angled 15° For retracting
and protecting superiorly
hinged corneal flaps.
[SV30-1772](#)



Mannis - Buratto

LASIK Flap Protector
blades angled 45°
For retracting and protecting
superiorly hinged corneal flaps.
[SV30-1773](#)



Rowen

Combination LASIK Flap
Protector and Spatula
[SV30-1774](#)



Dalk

Corneal Dissector
[SV30-1870](#)
12mm long, flattened,
vaulted spatula with
beveled tip

[SV30-1875](#)
Rosenwasser DALK Trisector
with triangular shaft and
spatulated tip



[SV30-1870](#)



[SV30-1875](#)



Endothelial Stripper

1mm wide, thin beveled tip
[SV30-1830](#)
smooth surface
[SV30-1835](#)
sosenwasser with textured surface

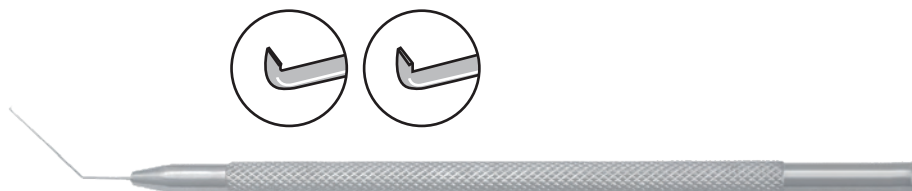

Sloane

LASEK Flap Repositor
gently curved spatulated tip
with beveled smooth edges
for repositing and smoothing
the epithelial flap after laser
ablation
[SV30-1845](#)



Camellin style

LASEK Trephine &
alcohol retaining well
[SV20-7830](#)
8mm trephine and
8.5mm well



Camellin Style

LASEK Alcohol Well
For retaining alcohol solution on
the corneal epithelium.
[SV30-1820](#) 8.5mm diameter
[SV30-1820 T](#) 8.5mm diameter titanium
[SV30-1822](#) 9.5mm diameter
[SV30-1822 T](#) 9.5mm diameter titanium



Anis

Capsule Scrubber flexible
wire textured disc
[SV30-1111](#)

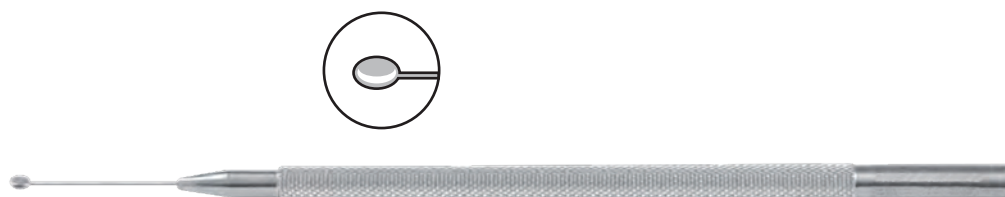

Lasik / Lasek / Dalk

Moran

LASIK Enhancement
Spatula Fukasaku spatula
and a modified paton spatula
[SV30-2524](#)

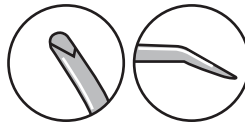

Corneal Dissector

for intrastromal dissection.
[SV20-3660](#)
angled, straight blade
[SV20-3661](#)
angled, curved blade

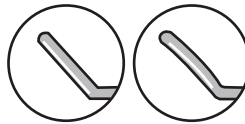

[SV20-3660](#) [SV20-3661](#)



Fogla Pointed Dissector

Fogla Pointed Dissector
[SV30-4924](#)



Carlson DSEK Smoother

Carlson DSEK Smoother
[SV30-2040](#)



Fogla Trifacet Spatula

Fogla Trifacet Spatula
[SV30-0479](#)



Hersh

Flap spatula beveled tips
a combination of a 6mm
spatula and 10mm spatula
[SV30-2526](#)

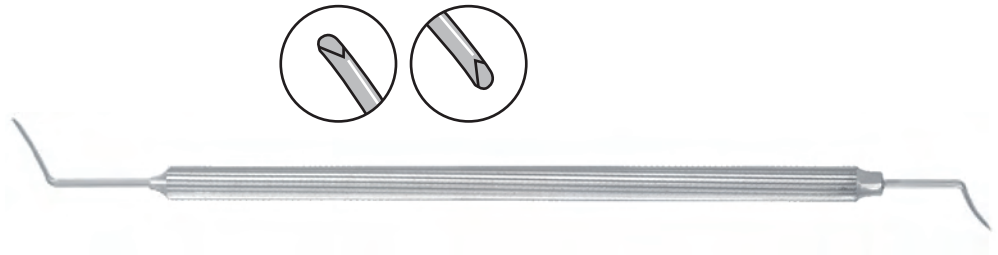

Binder

Flap elevator 1mm wide 12mm
semi-sharp edges
[SV30-2528](#)



Fukasaku

LASIK Spatula rounded anterior
and flat posterior surface with
beveled tip for lifting and
dissecting the corneal flap.
[SV30-2530](#)



Guimaraes

LASIK spatula
gently curved, bi-convex
semi-sharp edges
[SV30-2532](#)



Katzen

LASIK Flap "Unzipper"
combines a modified
sinskey hook and a
bi-convex spatula
[SV30-2534](#)

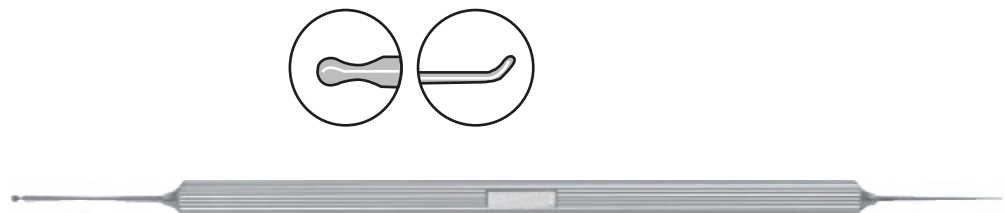

Maddox

LASIK Spatula
combines a flat spatula and
a cylindrical spatula for
elevating and repositing the flap
[SV30-2535](#)



Lasik / Lasek / Dalk

Thorlakson

Flap Lifter combines a modified Sinskey hook and a bi-convex spatula with beveled notches.

[SV30-2536](#) long handle
[SV30-2537](#) short handle

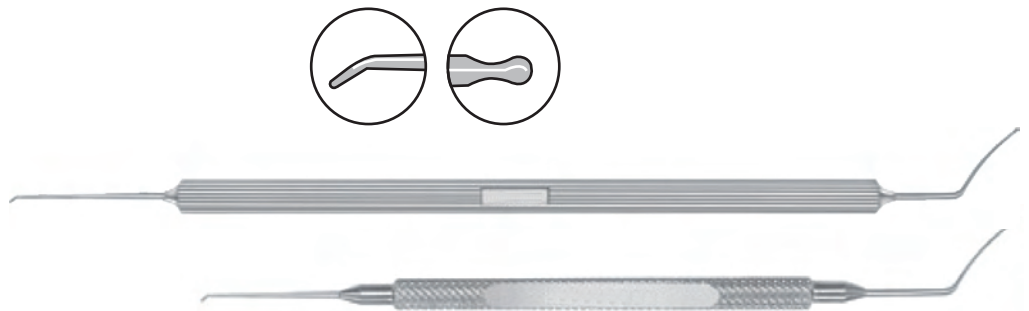

Lasik Flap Lifter

Combines a 45° angled sinskey hook and a thin hook with a tip

[SV30-2538](#)
[SV30-2538T](#) Titanium

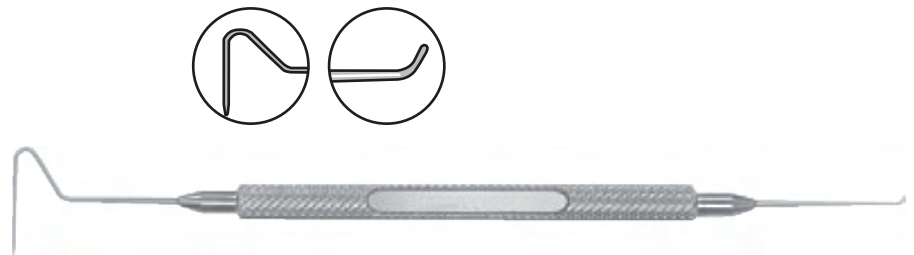

Spatulas/Choppers/Manipulators

Hirschman

Lens spatula flat
0.5mm wide with
multiple notches

[SV30-2550](#)



Jaffe

Lens spatula flat
0.5mm wide

[SV30-2600](#)



Lester

IOL Manipulator
0.25mm diameter tip ideal
for multi-directional manipulation
[SV30-2680](#) straight, with guard

IOL Manipulator
0.25mm diameter tip
vaulted shank
with guard
[SV30-2692](#)



Phaco chopper

Chopper 10mm angle to tip
blunt cutting tip

SV30-2180.8T

Chopper 10mm angle to tip
rounded front, 90° cutting edge.

SV30-2180.25T

Delicate 10mm angle to tip
short tip, 90° cutting edge.

SV30-2180.29T



SV30-2180.8T

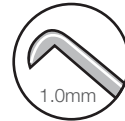

SV30-2180.25T



SV30-2180.29T



Mics Phaco Pre-chopper

For bimanual nucleus pre-chopping
SV30-2323 Alio-Rosen,
with two defined edges.

SV30-2324 Alio-Scimitar, curved
with blunt tip and sharp inferior edge.



SV30-2323



SV30-2324



SV30-2343

Milder

Phaco Chopper

60° offset inferior wedge
for horizontal chopping and a
beveled distal tip for vertical chopping

SV30-2343 for use in left hand

SV30-2343T for use in left hand titanium



Brierley

Nucleus Splitter

with incision sealing shaft

SV30-2380

SV30-2380T titanium



Dodick - Kammann

Nucleus Chopper

for bimanual nucleus division.

SV30-2382 1.5mm long tip, str

SV30-2383 1.5mm long tip, angled

SV30-2384 2mm long tip, straight

SV30-2385 2mm long tip, angled



SV30-2382



SV30-2384



SV30-2387

Escaf

Nucleus Divider

1.25mm long wedge shaped tip for
vertical chopping.

SV30-2387

SV30-2387T titanium



Choppers / Nucleus / Manipulators

Claw Chopper

1.5mm claw shape

[SV30-1446](#)

Green nucleus divider

cutting 45 degree to access, 65 degree angle shaft, tip to angle length 10mm

[SV30-1447](#)

Ball tip 0.7mm inferior wedge

[SV30-2327](#)

Naghara Phaco Chopper

Rounded, blunt tip 0.9mm inferior wedge

[SV30-2329](#)

[SV30-2329T](#) titanium

Phaco Chopper

rounded, blunt, olive-tip offset inferior wedge

[SV30-2332](#) for use in right hand

[SV30-2333](#) for use in left hand

Minardi Phaco Chopper

0.7mm long "Quick Chop" tip

[SV30-2370](#)

[SV30-2370T](#) titanium

Agarwal Karate Phaco Chopper

semi-sharp, wedge shaped inferior edge with a pointed tip.

[SV30-2375](#)

[SV30-2375T](#) titanium

Chang MicroFinger Chopper

curved finger shaped tip with defined inner edge for horizontal chopping

[SV30-2377](#)

Koch Nucleus Chopper

1.6mm long with blunted tip with rounded surfaces designed for safely splitting and dividing a very soft nucleus

[SV30-2386](#)

[SV30-2386T](#) titanium

Fukasaku wedge shaped inferior edge

[SV30-2392](#) Snapper Hook

[SV30-2393](#) Small pupil Snapper Hook

with notch to engage the iris

Rosen Phaco Splitter

wedge-shaped inferior edge blunt tip.

[SV30-2395](#) inline wedge, standard

[SV30-2395T](#) inline wedge, standard titanium

[SV30-2396](#) 60° offset wedge, for use in left hand.



[SV30-1446](#)



[SV30-1447](#)

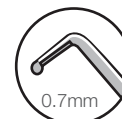

[SV30-2327](#)



[SV30-2329](#)



[SV30-2332](#)



[SV30-2333](#)



[SV30-2370](#)

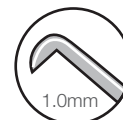

[SV30-2375](#)



[SV30-2377](#)



[SV30-2386](#)



[SV30-2392](#)



[SV30-2393](#)



[SV30-2395](#)



[SV30-2396](#)

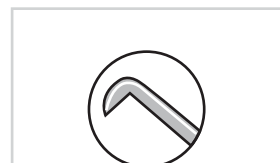

[SV30-2390](#)

Nagahara

Nucleus Spatula flat inferior edge

[SV30-2390](#)

[SV30-2390T](#) titanium

[SVM30-2390A](#) french Pattern

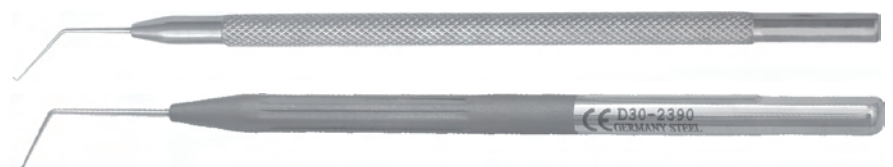

Gimbel

Nucleus Spatula
round, smooth
angled 30° at
10mm from the tip
0.25mm diameter
[SV30-2312](#)



Knolle

Nucleus Spatula
malleable stainless steel,
flat 0.5mm wide
[SV30-2350](#)

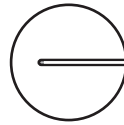

Koch

Nucleus Spatula gently
curved duckbill shaped tip
[SV30-2354](#) smooth
[SV30-2355](#) with notches

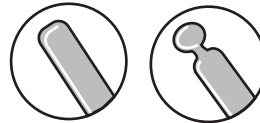

Escaf

Nucleus Manipulator
flattened olive-shaped tip angled at 45°
[SV30-2347](#)
[SV30-2347T](#) titanium



[SV30-2347](#) [SV30-2357](#) [SV30-2359](#)

Akahoshi

0.5mm diameter bulbous tip,
tip length 1.5mm 45° angled
shaft, tip to angle length 10.0mm
[SV30-2357](#)
[SV30-2357T](#) titanium

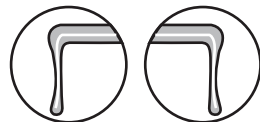

[SV30-2360](#) [SV30-2361](#)

Escaf

Nucleus Sustainer
smooth ball tip textured inferior surface
[SV30-2359](#)

Lieberman

MicroFinger Nucleus Manipulator
[SV30-2360](#) for use in right hand
[SV30-2361](#) for use in left hand



Spatulas / Choppers / Manipulators

Neuhann

Nucleus Divider
strongly curved spatulated tip
[SV30-2388](#)



Tennant

Nucleus Rotator
with 0.6mm diameter
ball shaped tip
[SV30-2428](#)
[SV30-2428T titanium](#)



Hunkeler

IOL Manipulator
with 0.3mm diameter
hemi-ball tip,
vaulted shank
[SV30-2695](#)



Mushroom

IOL manipulator angled
with 0.65mm diameter ball tip
[SV30-2696](#)
[SV30-2696T titanium](#)



Nucleus sustainer

Nucleus splitter and sustainer,
curved, blunt tip to be used
with the prechoppers
[SV30-2192.01T titanium](#)

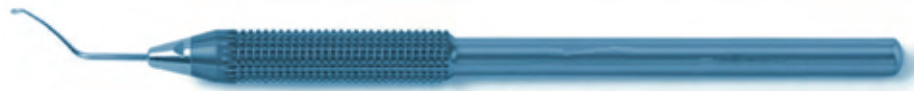

Scoring reverse hook

"Scoring" reverse hook for DSEK,
sharp, angled
[SV30-2183.10T titanium](#)
DSEK stripper,
"T" shaped tips
[SV30-2183.12T titanium](#)



Masket

a combination of the Rosen Phaco Splitter and a 12mm long round Phaco Spatula with disc shaped tip

[SV30-2367](#)

[SV30-2367T](#) titanium

Chang

Phaco Chopper a combination of a modified MicroFinger and a 0.9mm long "Quick Chop" tip.

[SV30-2368](#) for use in right hand

[SV30-2369](#) for use in left hand

Milder

Phaco Chopper, double-end 60° for a beveled distal tip for vertical chopping and 12mm long spatula disc-shaped tip

[SV30-2344](#) for use in right hand

[SV30-2345](#) for use in left hand

Hwang

Phaco Chopper 1mm long vertical chopper and a chisel tipped spatula

[SV30-2374](#)

[SV30-2374T](#) titanium

Warren

Combination of a 3.5mm long MicroFinger and 2mm long pointed "Quick Chop" tip for veterinary use only.

[SV30-2379](#)

Rowen

Phaco Spatula a combination of the Rosen Phaco Splitter and the Bechert Nucleus Rotator

[SV30-2398](#)

[SV30-2398T](#) titanium

Chang - Seibel

Phaco Chopper, a combination chopper with the Chang MicroFinger end and Seibel Vertical Chopper

[SV30-2340](#) for use in right hand

[SV30-2341](#) for use in left hand

Sharp Chopper & Blunt Chopper

A combination sharp chopper & blunt chopper

[SV30-2705](#)

[SV30-2705T](#) titanium

Mushroom & Chopper

A combination of the mushroom and nagahara chopper

[SV30-2698](#)

[SV30-2698T](#) titanium

Mushroom & Y Pusher

A combination of mushroom and Y pusher bechert

[SV30-2699](#)

[SV30-2699T](#) titanium

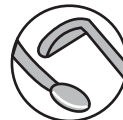

[SV30-2367](#)



[SV30-2368](#)

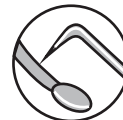

[SV30-2344](#)



[SV30-2374](#)



[SV30-2379](#)



[SV30-2398](#)



[SV30-2340](#)



[SV30-2705](#)



[SV30-2698](#)



[SV30-2699](#)

Spatulas / Choppers / Manipulators

Double Ended

Combination of 0.65mm mushroom tip and Nucleus Splitter

SV30-085

SV30-085T titanium

Combination of nagahara blunt chopper and sinskey hook

SV30-086

SV30-086T titanium

Combination of 0.65mm mushroom and sinskey hook

SV30-087

SV30-087T titanium

Combination of nagahara blunt chopper and spatula

SV30-088

SV30-088T titanium

Combination of sinskey hook and spatula

SV30-089

SV30-089T titanium

Combination of 0.65mm mushroom tip and spatula

SV30-090

SV30-090T titanium

Combination of 0.65mm mushroom tip and Y bechurt

SV30-091

SV30-091T titanium

Combination of sinskey hook and Y bechurt

SV30-092

SV30-092 T titanium

Combination of nagahara blunt chopper and Y bechurt

SV30-093

SV30-093T titanium

Combination of 0.65mm mushroom tip and sharp chopper

SV30-094

SV30-094T titanium

Combination of sinskey hook and sharp chopper

SV30-095

SV30-095T titanium

Combination of nagahara blunt chopper and sharp chopper

SV30-096

SV30-096T titanium



SV30-085T



SV30-086T



SV30-087T



SV30-088T

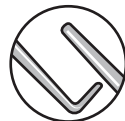

SV30-089T



SV30-090T



SV30-091



SV30-092



SV30-093



SV30-094



SV30-095



SV30-096

Bechert

Nucleus Rotator blunt forked tip

SV30-2400 angled at 7mm

SV30-2400T angled at 7mm titanium

SV30-2410 angled at 9mm

SVT30-2410 angled at 9mm titanium

Bechert

Lens Pusher vertical Y-shaped tip angled.

SV30-2727

SV30-2727T titanium

Drysdale

Nucleus Manipulator paddle shaped tip

SV30-2418 rounded edges

SVT30-2418T rounded edges titanium

SV30-2419 defined anterior edge for capsule polishing

Pisacano

Nucleus Rotator flat disc shaped tip

SV30-2420 horizontal

SV30-2420T horizontal titanium

SV30-2421 vertical

SV30-2421T vertical titanium

Siepsier

Endocapsular Controller trumpet shaped tip

SV30-2425

Anis

Nucleus Manipulator

with 0.5mm diameter ball tip

SV30-2426 straight

SV30-2427 angled

Grayson

Nucleus Manipulator flattened, smoothly polished 1.1mm long with "tear-drop" shaped tip.

SV30-2417

Lester

IOL Manipulator 0.25mm diameter

tip Ideal for

multi-directional manipulation.

SV30-2690

SV30-2690T titanium

IOL Manipulator 0.25mm

diameter tip vaulted shank

For engaging the inferior





haptic without touching the

dome of the IOL.

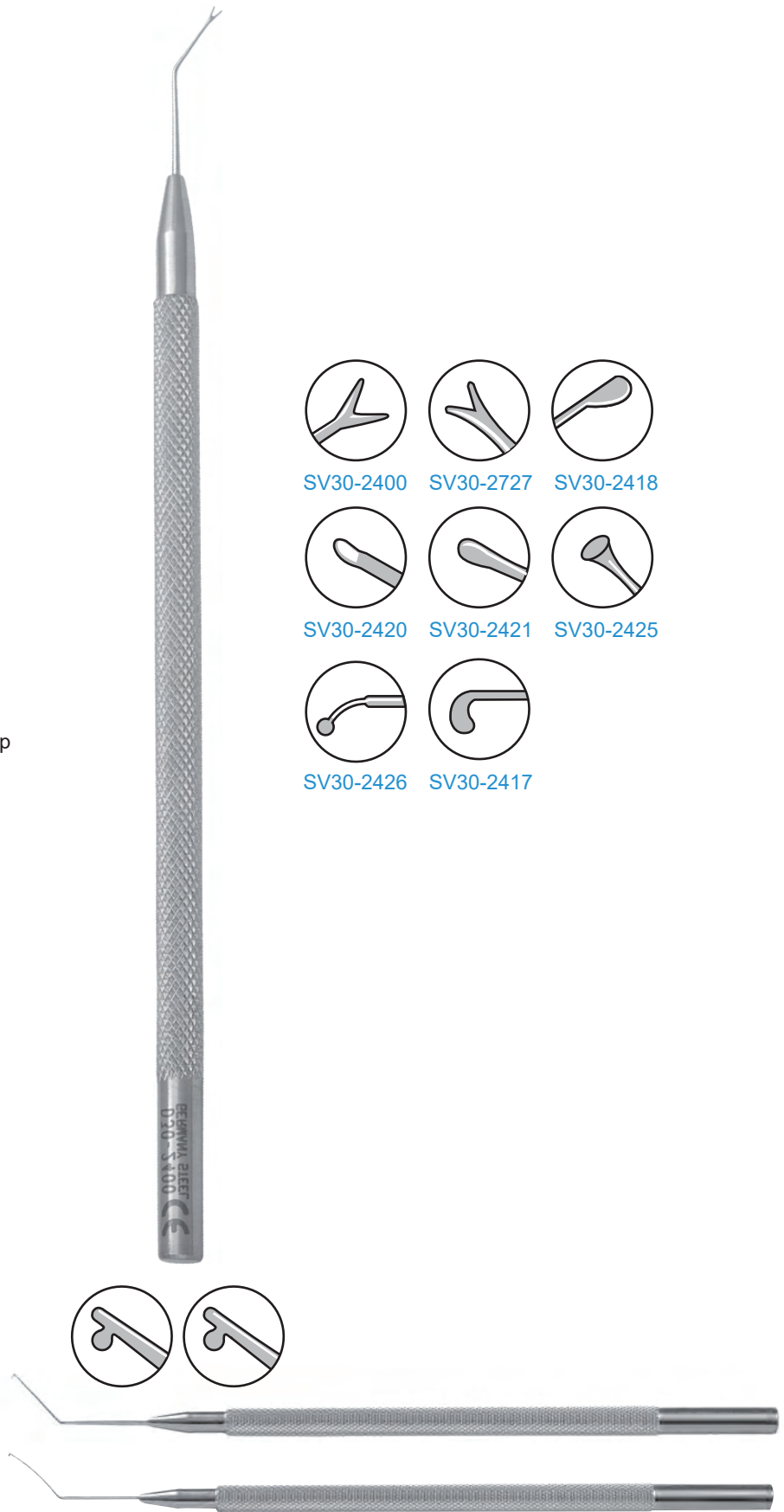
SV30-2691

SV30-2691T titanium



- 
SV30-2400
- 
SV30-2727
- 
SV30-2418
- 
SV30-2420
- 
SV30-2421
- 
SV30-2425
- 
SV30-2426
- 
SV30-2427

Hooks / Manipulators

Reversed Sinskey Hook

0.2mm diameter blunt tip for scoring the recipient endothelium and positioning the donor lamella.

[SV30-5002](#)

Sinskey

Lens Manipulating Hook round handle
0.25mm diameter blunt tip

[SV30-5192](#) straight, with guard

[SV30-5193](#) angled

[SV30-5193T](#) angled titanium

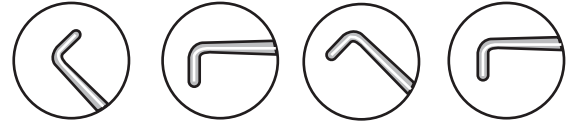

[SV30-5002](#)

[SV30-5192](#)

[SV30-5193](#)

[SV30-5232](#)

Sinskey II

Lens Manipulating Hook

0.2mm diameter blunt tip round handle

[SV30-5232](#) straight, with guard

[SV30-5233](#) angled

[SV30-5233T](#) angled titanium



[SV30-5233](#)

[SV30-5250](#)

[SV30-5400](#)

Lewicky

Lens Manipulating Hook

0.15mm dia blunt tip ang vaulted shank

[SV30-5250](#)

[SV30-5250T](#) titanium



Hirschman

Iris Hook blunt, angled

[SV30-5400](#)

Bonn

Micro Iris Hook blunt, flat handle

[SV30-5060](#)

Shepard

Iris Hook blunt

[SV30-5110](#)

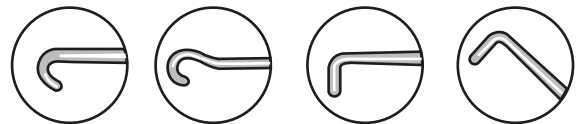

[SV30-5060](#)

[SV30-5110](#)

[SV30-5160](#)

[SV30-5170](#)

Lens Manipulating Hook

0.15mm diameter blunt tip

[SV30-5160](#) Jaffe, straight

[SV30-5170](#) Clayman-Jaffe, angled

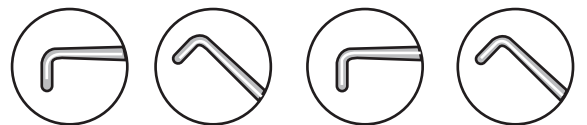

[SV30-5180](#)

[SV30-5190](#)

[SV30-5220](#)

[SV30-5230](#)

Sinskey

Lens Manipulating Hook

0.25mm diameter blunt tip straight

[SV30-5180](#)

Harris - Sinskey

Lens Manipulating Hook

0.25mm diameter blunt tip angled

[SV30-5190](#)



Sinskey II

Lens Manipulating Hook

0.2mm diameter blunt tip

[SV30-5220](#) straight

[SV30-5230](#) angled

Spatulas / Manipulators

Castroviejo

Synechiaie Spatula 0.5mm wide with semi-sharp tips.

[SV30-3150](#)

Castroviejo

Cyclodialysis Spatula

[SV30-3200](#) 0.25mm wide

[SV30-3210](#) 0.5mm wide



Kimura

Platinum Spatula

[SV30-3500](#)



Nucleus Dividing and Separating

size: 0.6×1.2mm tip oval

[SV30-52001](#)

size: 0.4×1.0mm tip oval

[SV30-52003](#)

size: 0.4×0.65mm tip oval

[SV30-52004](#)

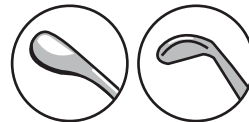

Straight Ring Manipulator

Straight shaft

0.5mm inside diameter, 0.8mm outside diameter, rounded tip

Round handle, length 121mm

[SV30-6462](#)

0.5mm inside diameter, 0.8mm outside diameter, rounded tip

Angled shaft, tip to angle length 10mm

Round handle, length 118mm

[SV30-6462-1](#)

0.8mm diameter, rounded tip

Angled shaft, tip to angle length 10mm

Round handle, length 118mm

[SV30-6462-2](#)



Hooks / Manipulators

Kuglen Iris & Hook Lens Manipulator

[SV30-5500](#)

Push-pull model, flat handle, straight

[SV30-5520](#)

Push-pull model, flat handle, angled

[SV30-5510](#)

Clover leaf model, flat handle, straight

[SV30-5522](#)

Push-pull model, round handle, straight w/guard

[SV30-5523](#)

Push-pull model, round handle, angled

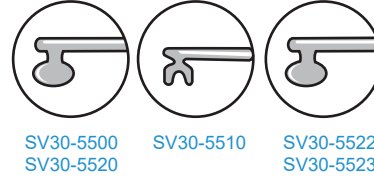

Lens Manipulator

straight, with guard

[SV30-5526](#) Rentsch, "Boat Hook"

[SV30-5528](#) Osher, Y-hook

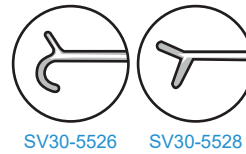

Lens Manipulating Hook

0.15mm diameter tip

[SV30-5530](#) Fenzl, round handle

straight with guard

[SV30-5531](#) Fenzl,

round handle, angled

[SV30-5532](#)

Maltzman-Fenzl,

round handle,

straight with guard

[SV30-5533](#) Maltzman-Fenzl,

round handle,

angled

[SV30-5535](#) Jaffe-Maltzman,

flat handle, angled

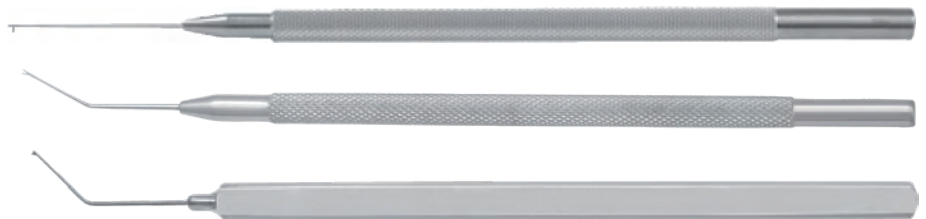
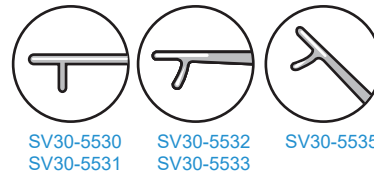

Deltz

0.15mm diameter tip

[SV30-5566](#)



Alio - Kelman

IOL Hook 0.2mm diameter tip

[SV30-2697](#)



Fixation Hook

double, sharp
SV30-6000
SV30-6010



Twist Hook

for scleral fixation
SV30-6100 right
SV30-6110 left

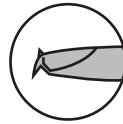

Silverman

Fixation Pick
blunt cone shaped tips
spaced 3mm apart
for atraumatic scleral fixation
SV30-6130

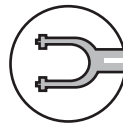

Globe Ring

Globe Fixation Ring
with concentric grooves
SV30-6153 for refractive procedures
SV30-6154 for cataract procedures

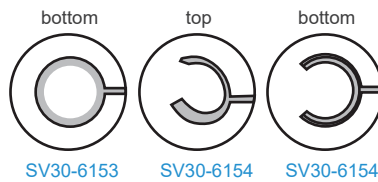

Lu - Mendez

LRI Guide and Fixation Ring
with delicate blunt teeth marks 10°
increments 11mm I.D.
SV30-6158
SV30-6158T titanium



Fixation Rings

Gimbel

Stabilization Ring
with swivel handle
13mm diameter with blunt teeth
on both sides
For stabilizing either the right or
left eye during LASIK.
[SV30-6160](#)



Fine - Thornton

Swivel Fixation Ring
blunt teeth features marks on anterior
surface in 15° increments as a guide
for placement of limbal relaxing incisions.
[SV30-6161T](#) 13mm diameter titanium
[SV30-6161](#) 13mm diameter
[SV30-6163](#) 16mm diameter

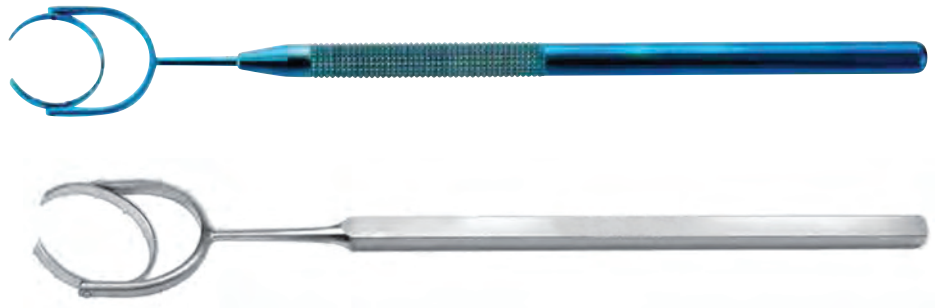

Thornton

Globe Fixation Ring
multiple blunt teeth
16mm diameter ring
[SV30-6165](#)
[SV30-6165T](#) titanium



Hofmann - Thornton

Globe Fixation Ring
with swivel handle
16mm diameter ring
multiple blunt teeth
[SV30-6168](#)



Stevens

Tenotomy Hook
blunt, small
SV30-6600



Helveston

"Teaser" Hook
extra delicate, blunt
SV30-6610



Graefe

Muscle Hook
SV30-6710 size 1
SV30-6720 size 2
SV30-6730 size 3

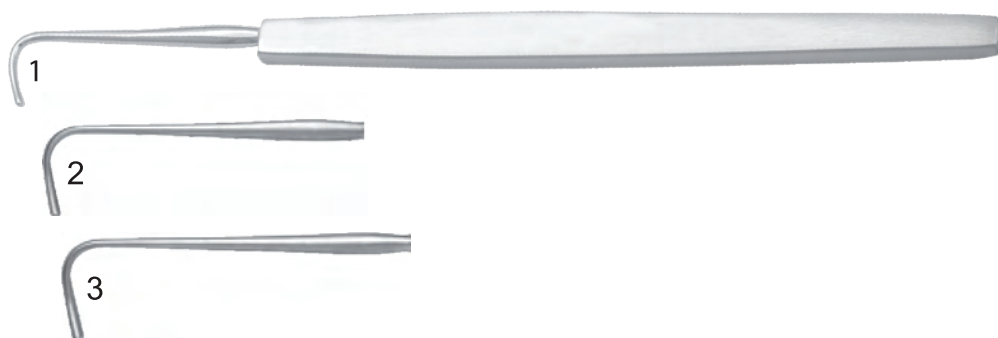

Gass

Retinal Detachment
Hook with oval hole
SV30-6740



Helveston

Muscle Hook
extra delicate,
with blunt spatulated tip
SV30-6760 large
SV30-6761 small



Muscle Hooks

Helveston

Muscle Hook
extra delicate, with blunt
spatulated tip

[SV30-6778](#) 8mm
[SV30-6780](#) 10mm
[SV30-6782](#) 12mm



Jameson

Muscle Hook
[SV30-6800](#) small
[SV30-6810](#) large



Du Plessis

Muscle Hook
double arm
[SV30-6814](#)



Guyton

Small Incision
Muscle Hook
[SV30-6820](#)



Green

Muscle Hook
[SV30-6850](#)



Moorfields

Moorfields
Strabismus Hook
[SV30-6851](#)



Mendez

Degree Gauge 12mm I.D.
marked in 10° increments
for accurate axial
alignment on the cornea
SV30-7900T titanium
SV30-7900



Bores

Axis Marker
SV30-7910T titanium
SV30-7910



Henderson

Degree Gauge 11.7mm I.D.
Beveled face with markings
in 5° increments 4 notches
on internal edge to align
with cardinal positions
SV30-7904T titanium

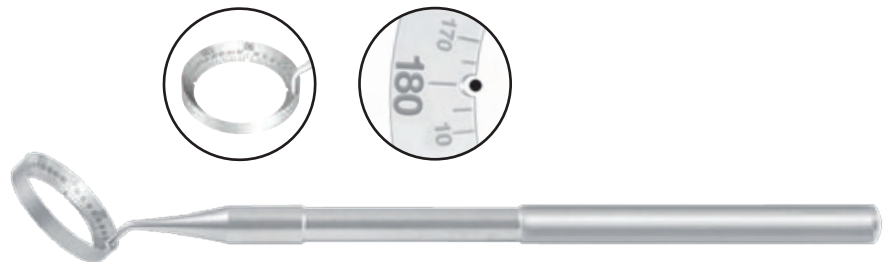

Henderson

Toric IOL Marker
two 2.5mm radial
marks extending to 11mm
(used with ST30-7904)
SV30-7912T titanium

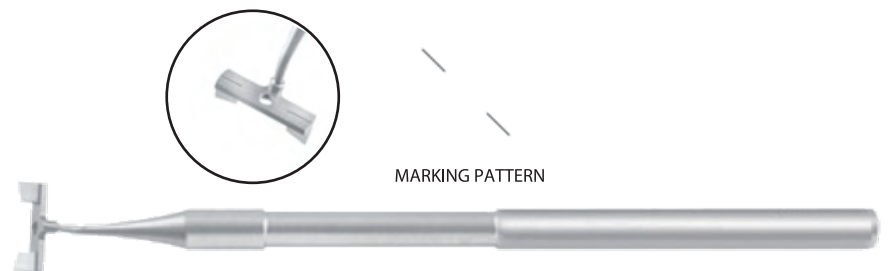

Henderson

Henderson Alignment Marker
with atraumatic disc-shaped
marking surfaces
at 3, 6 & 9 o'clock
SV30-7908T titanium



Corneal Markers

Optic Zone Markers

Bores	Hoffer, with cross hairs
SV30-8130 3.0mm	SV30-8330 3.0mm
SV30-8131 3.25mm	SV30-8340 3.25mm
SV30-8132 3.5mm	SV30-8360 3.75mm
SV30-8134 4.0mm	SV30-8370 4.0mm
SV30-8135 4.25mm	SV30-8380 4.25mm
SV30-8136 4.5mm	SV30-8390 4.5mm
SV30-8137 4.75mm	SV30-8400 4.75mm
SV30-8138 5.0mm	SV30-8410 5.0mm
SV30-8142 6.0mm	SV30-8412 5.5mm
SV30-8146 7.0mm	SV30-8414 6.0mm
SV30-8150 8.0mm	SV30-8418 7.0mm
SV30-8154 9.0mm	SV30-8422 8.0mm
	SV30-8426 9.0mm



Anis

Radial Marker 4mm diameter center opening 12.5mm O.D.
S30-8852 8 blades
[SV30-8854](#) 12 blades
[SV30-8855](#) 16 blades



Anis

Suture Placement Marker
8 radial blades
8mm diameter center opening for corneal grafts.
[SV30-8862](#)



Fechtner

Trabeculectomy Marker
[SV30-8975](#)



MARKING PATTERN



McDonald

Optic Zone Marker
double end, with cross hairs
[SV30-8117](#)
6.5 and 7.0mm diameters



Osher Neumann

Osher-Neumann
Corneal Marker
[SV30-8000](#) 4 Line
[SV30-8001](#) 8 Line
[SV30-8002](#) 12 Line



PRK Scraper

combination of
PRK Scraper and Marker
6.5mm marker
total length 112mm
[SV30-8003](#)



Double Ended Marker

5mm diameter on one side
5.5mm opposite
[SV30-8004](#)



Maloney

Intra-Operative
Keratometer titanium
for qualitative measurement
of astigmatism.
[SV30-7888T](#) titanium
[SV30-7888](#)



Calipers

Castroviejo

Caliper
20mm spread
[SV30-9000](#) straight
[SV30-9002](#) angled
[SV30-9010](#) curved

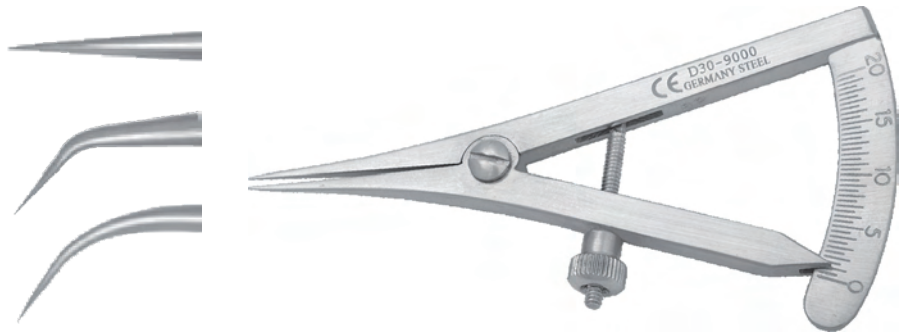

Helveston

Scleral Ruler
15mm long, with notches
in 5mm increments single
marking tooth at tip for
measuring and marking the
distance from the limbus to
the location of the muscle
reinsertion.
[SV30-9030](#)

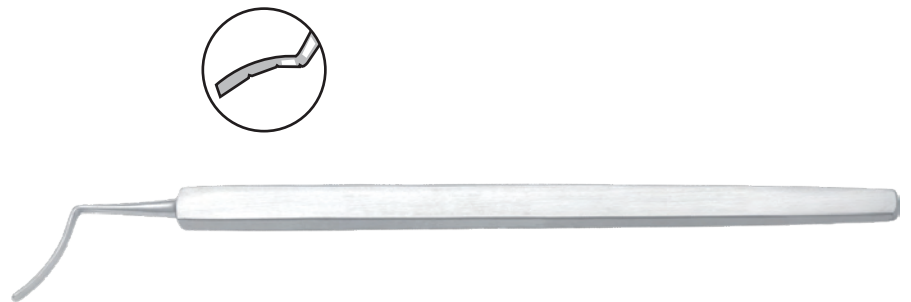

Jameson

Caliper
chrome plated brass
[SV30-9150](#)



Ruler

Stainless Steel
inches and mm
[SV30-9200](#)



Braunstein

Caliper
3.5/4.0mm
Stainless steel
[SV30-9250](#)
[SV30-9251](#)



SV40

- Scissors

Vitreotomy Scissors

“Squeeze Handle” Scissors
these “squeeze handle” instruments feature titanium handles to reduce overall weight, and front ends of hardened stainless steel for secure cutting

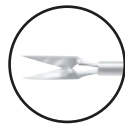

Scissors

horizontal I, straight

- SV40-5300 20G 0.8 S.S
- SV40-5300T 20G 0.8 titanium
- SV40-5301 23G 0.6 S.S
- SV40-5301T 23G 0.6 titanium

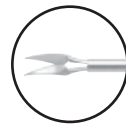

Scissors

horizontal, curved

- SV40-5310 20G 0.8 S.S
- SV40-5310T 20G 0.8 titanium
- SV40-5423 23G 0.6 S.S
- ISTD40-5423 23G 0.6 titanium
- SV40-5425 25G 0.50 S.S
- SV40-5425T 25G 0.50 titanium

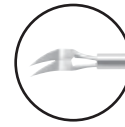

Scissors

horizontal, angled 45°

- SV40-5320 20G 0.8 S.S
- SV40-5320T 20G 0.8 titanium
- SV40-5321 23G 0.6 S.S
- SV40-5321T 23G 0.6 titanium

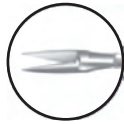

Scissors

vertical opening straight

- SV40-5200 20G 0.8 S.S
- SC40-5200T 20G 0.8 titanium
- SV40-5201 23G 0.6 S.S
- SV40-5201T 23G 0.6 titanium



Scissors

vertical opening angled

- SV40-5240 20G 0.8 S.S
- SV40-5240T 20G 0.8 titanium



Scissors

vertical opening angled

- SV40-5250 20G 0.8 S.S
- SV40-5250T 20G 0.8 titanium

Alio

MICS scissors

23 gauge curved shaft with horizontal micro blades for cutting delicate membranes

SVT40-5351 titanium



Horizontal blade



Vertical blade

YAE

Multi - Purpose 23G

vertical blade

SVT40-5352 3mm blade 24mm long shaft 112mm

SVT40-5353 2.5mm blade, 15mm long curved shaft 100mm



Scissors

Castroviejo

Corneoscleral Scissors

small blades

SV40-1000 right

SV40-1010 left

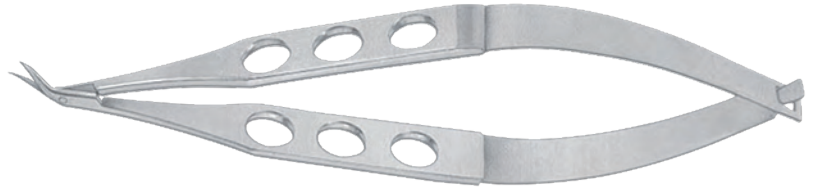

Castroviejo

Corneoscleral Scissors

medium blades

SV40-1020 right

SV40-1030 left



Troutman - Castroviejo

Corneoscleral Scissors

with stop, small blades

SV40-1200 right

SV40-1210 left



Troutman - Castroviejo

Corneoscleral Scissors

with stop, medium blades

SV40-1220 right

SV40-1230 left



Castroviejo

Corneal Transplant Scissors

with stop

strong curve, small blades

SV40-2000 right

SV40-2010 left



Rich

Corneal Transplant Scissors
extremely delicate, strongly
curved blades for trimming the
recipient corneal bed and donor
button. Can also be used for
open sky anterior capsulotomy.

SV40-2014 right

SV40-2015 left



Terry

Micro Corneal Scissors
round handle for
meticulous control.

SV40-2016 right

SV40-2017 left



Katzin

Corneal Transplant Scissors
strong curve, medium blades

SV40-2020 right

SV40-2030 left



Castroviejo

Universal Corneal Scissors
curved, blunt tips

SV40-2200 small blades

SV40-2220 medium blades

SV40-2240 large blades

SV40-2260 strongly curved

large blades

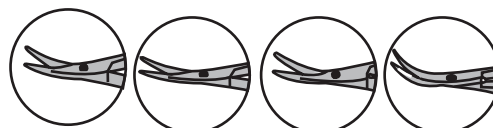

SV40-2200

SV40-2220

SV40-2240

SV40-2260



Castroviejo

Keratoplasty Scissors
angled to side
blunt tips, medium blades

SV40-2850



Scissors

Corneal scissors

curved, 10mm long blades,
[SV40-1464-1](#) pointed tips curved
[SV40-1464-2](#) blunt tips



[SV40-1464-1](#)



Conjunctival scissors

curved, 10mm long blades,
[SV40-1540-1](#) pointed tips curved
[SV40-1540-2](#) reverse blades
[SV40-1540-2](#) blunt tips

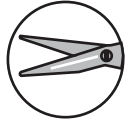

Conjunctival scissors

curved, 11mm long blades,
blunt tips
[SV40-1543](#)

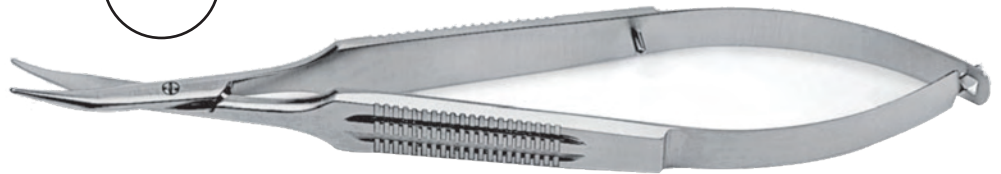

Conjunctival scissors

curved, 8mm long blades,
blunt tips
[SV40-1546](#)

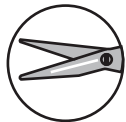

IOL removal scissors

Cutting scissors for removal of
IOL straight, blunt tips, 8mm long
with serrated lower blade
[SV40-1690](#)



IOL removal scissors

Cutting scissors for removal of
IOL angled, blunt tips, 8mm long
with serrated lower blade
[SV40-1691](#)



McPherson - Westcott

Conjunctival Scissors curved
blunt tips, small blades.
[SV40-3000](#)



Westcott

Tenotomy Scissors
blunt tips, medium blades
curved.
[SV40-3004](#)



Westcott

Tenotomy Scissors
blunt tips, standard blades curved
[SV40-3100](#) right
[SV40-3110](#) left



Tibolt

Punctal Scissors
one conically shaped blade
with micro grooves and
textured surface for simple
"Two-snip Punctoplasty"
[SV40-3130](#)



Mini Westcott

Tenotomy Scissors
4mm long curved blades
blunt tips.
[SV40-3200](#)



Scissors

McPherson - Westcott

Stitch Scissors
very sharp pointed
tips small blades curved.
[SV40-4000](#)

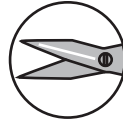

Westcott

Stitch Scissors
very sharp pointed tips
standard blades curved
[SV40-4100](#)



Jaffe

Stitch Scissors
very sharp pointed tips
medium blades curved
[SV40-4150](#)



Iris

Scissors
sharp tips, small blades
[SV40-4400](#) straight
[SV40-4410](#) curved



Fine

Stitch Scissors
sharp tips, medium blades
[SV40-4500](#) straight
[SV40-4510](#) curved



Scissors

Barraquer

Iris Scissors
blunt tips, 7mm long blades.
SV40-4900



Capsulotomy Scissors Vannas

5mm long blades, sharp tips
SV40-5000 straight
SV40-5010 curved
SV40-5020 angled forward
SV40-5030 angled to side



Gills - Vannas

7mm long blades, sharp tips
SV40-5050 straight
SV40-5060 curved
SV40-5070 angled forward



Mcpherson - Vannas

8mm long blades, sharp tips.
SV40-5100 curved

Capsulotomy Scissors Vannas

7mm extra thin long blades, sharp tips
SV40-5110 straight
SV40-5111 curved
SV40-5112 angled forward
10mm extra thin long blades, sharp tips
SV40-5120 straight
SV40-5121 curved
SV40-5122 angled forward
SV40-5123 curved, angled, forward
10mm long angled blades, curved tips
SV40-5125 sharp points
SV40-5126 blunt points



Eye Scissors

pointed tips small
SV40-7200 straight
SV40-7210 curved

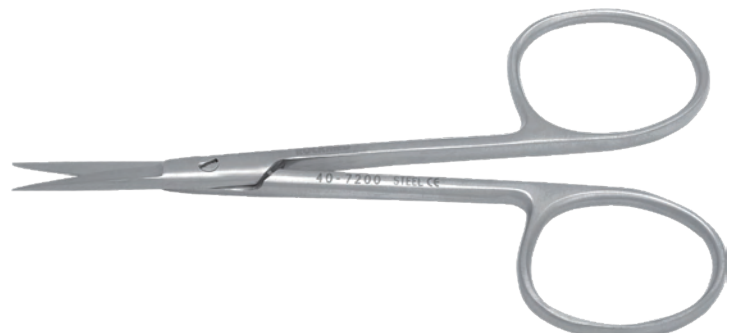

Eye Scissors

pointed tips standard

SV40-7400 straight

SV40-7410 curved

SV40-7400TC Tungsten Carbide Str

SV40-7410TC Tungsten Carbide Cvd

SV40-7400SC Super Cut Str

SV40-7410SC Super Cut Cvd



Eye Scissors

large rings pointed

tips standard

SV40-7440 straight

SV40-7450 curved

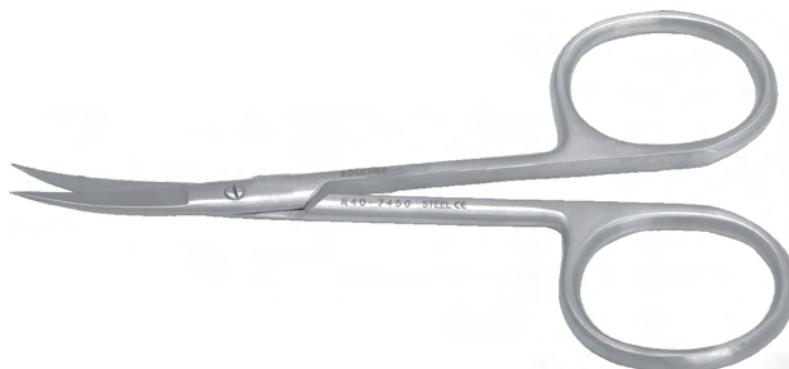

Stitch Scissors

ribbon type

needle points curved

SV40-8000

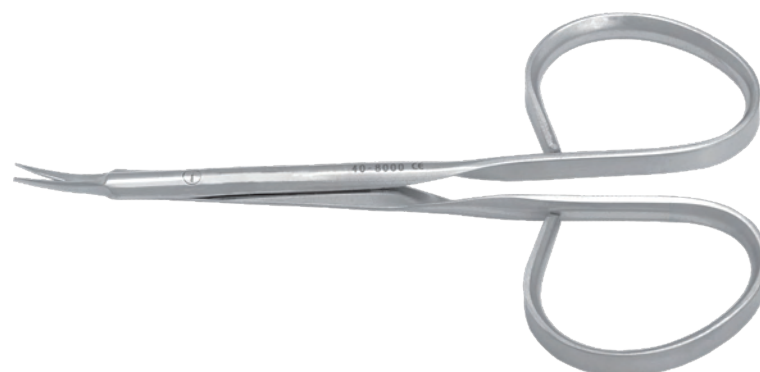

Stitch Scissors

needle points

light curve

SV40-8100



Scissors

Stevens

Tenotomy Scissors
blunt tips standard

D40-8500 straight

D40-8510 curved

D40-8500TC Tungsten Carbide Str

D40-8510TC Tungsten Carbide Cvd

D40-8500SC Super Cut Str

D40-8510SC Super Cut Cvd



Stevens

Tenotomy Scissors
ribbon type blunt tips

SV40-8520 straight

SV40-8530 curved

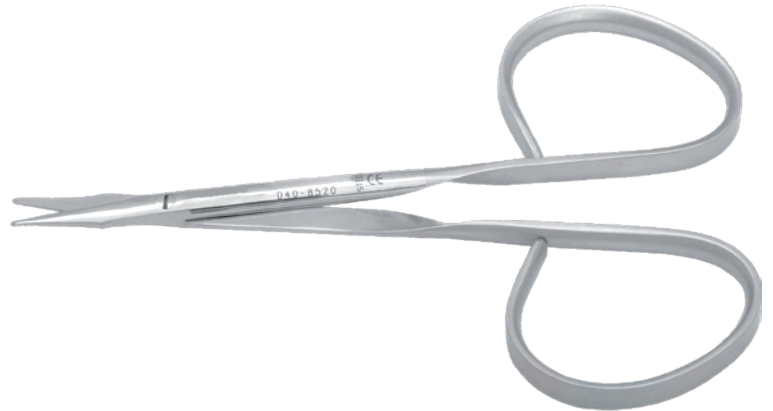

Knapp

Strabismus Scissors
blunt tips

SV40-9000 Straight

SV40-9010 curved

SV40-9000TC Tungsten Carbide Str

SV40-9010TC Tungsten Carbide Cvd

SV40-9000SC Super Cut Str

SV40-9010SC Super Cut Cvd

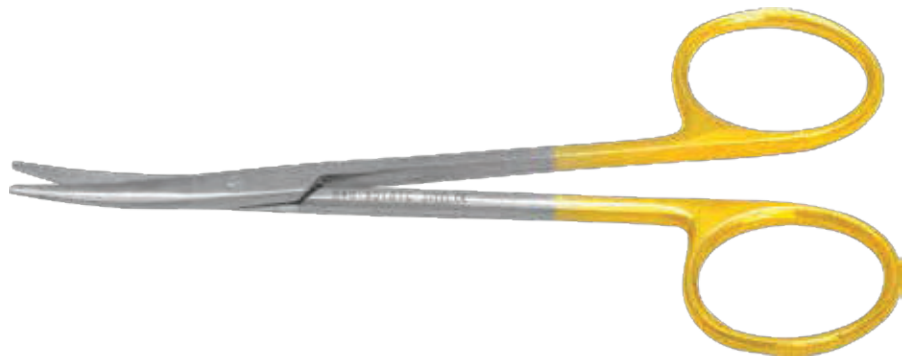

Strabismus Scissors

ribbon type blunt tips

SV40-9020 straight

SV40-9030 curved

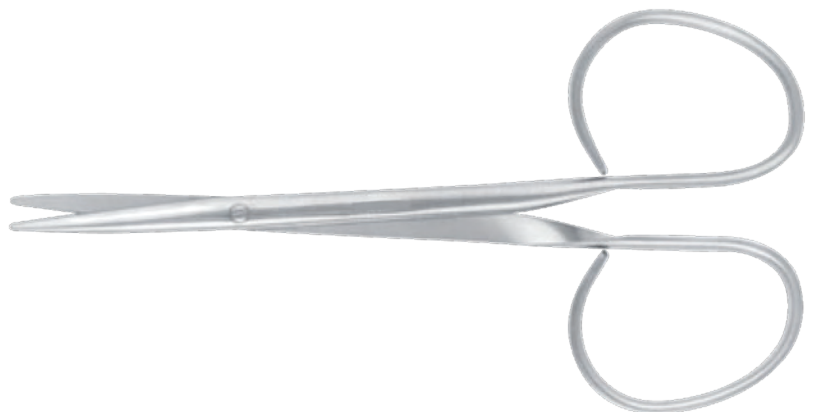

Metzenbaum

Dissecting Scissors
gently curved blades
blunt tips
5 3/4" (14.5cm)
long

[SV40-9040](#)

[SV40-9040TC Tungsten Carbide](#)

[SV40-9040SC Super Cut](#)



Utility Scissors

one pointed and one
blunt tip
5 3/4" (14.5cm) long
straight

[SV40-9060](#)

[SV40-9060TC Tungsten Carbide](#)

[SV40-9060SC Super Cut](#)



Enucleation Scissors

blunt tips
[SV40-9910](#)
medium curve
[SV40-9920](#)
strong curve

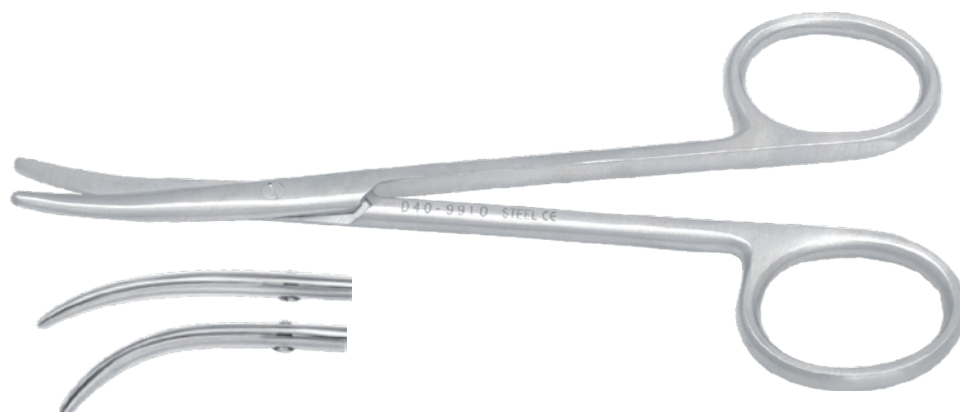

Black Coated Super Cut Scissors

black coated super cut Iris scissors

[SVSCB40-7400 Str](#)

[SVSCB40-7410 Cvd](#)



SV50

- Forceps

ICL forceps

ICL forceps for
loading, angled tips

SV50-75666 S.S

SV50-75666T titanium



Foldable Lens Cutter Squeeze

Titanium Handle 112mm

SV-4-21731T titanium

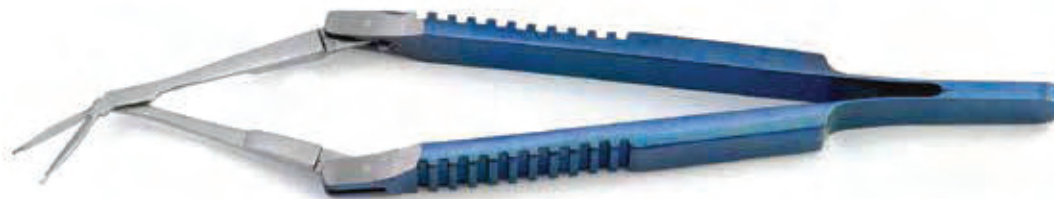

IOL Lens Cutter

IOL Lends cutter/Holder with one serrated
blade stainless steel

SV50-0787T titanium



Foldable Lens Removing Forceps

Titanium Handle 110mm

SV-4-21741T titanium



Retinal Forceps

Vitreous - Retinal Forceps

Stainless Steel Autoclavable



Stainless Steel Autoclavable



Subretinal Forceps
Angled 135°, 4.5mm
from the tip
SV50-7500 20G/0.9



Serrated jaws
straight
SV50-7501 20G/0.9
SV50-7502 23G/0.6



ILM Forceps
2.2mm long with
shaft size 27.5mm
SV50-7503 20G/0.9
SV50-7504 23G/0.6



End gripping forceps
straight
SV50-7505 20G/0.9
SV50-7506 23G/0.6



Serrated ILM
Forceps, 1.25mm
Long – with fine pick.
SV50-7507 20G/0.9
SV50-7508 23G/0.6



Spaide Pic forceps,
SV50-7510 20 G/0.9
SV50-7511 23 G/0.6



Asymmetrical
End-gripping Forceps,
SV50-7512 20 G/0.9
SV50-7513 23 G/0.6



Eckardt End-gripping
Forceps,
SV50-7514 20 G/0.9
SV50-7515 23 G/0.6



ILM forceps,
SV50-7516 20 G/0.9
SV50-7517 23 G/0.6

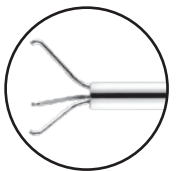

Foreign Body Forceps
Basket style with three
gripping arms.
SV50-7518 20 G/0.9

Vitreo - Retinal Forceps



Titanium



Subretinal Forceps
Angled 135°,
4.5mm from the tip

SV50-7500T 20G/0.9



Serrated jaws
straight

SV50-7501T 20G/0.9
SV50-7502T 23G/0.6



ILM Forceps
2.2mm long with
shaft size 27.5mm

SV50-7503T 20G/0.9
SV50-7504T 23G/0.6



End gripping forceps
straight

SV50-7505T 20G/0.9
SV50-7506T 23G/0.6



Serrated ILM
Forceps, 1.25mm
Long – with fine pick.

SV50-7507T 20G/0.9
SV50-7508T 23G/0.6



Spaide Pic forceps,

SV50-7510T 20 G/0.9
SV50-7511T 23 G/0.6



Asymmetrical
End-gripping Forceps,

SV50-7512T 20 G/0.9
SV50-7513T 23 G/0.6



Eckardt End-gripping
Forceps,

SV50-7514T 20 G/0.9
SV50-7515T 23 G/0.6



ILM forceps,

SV50-7516T 20 G/0.9
SV50-7517T 23 G/0.6



Foreign Body Forceps
Basket style with three
gripping arms.

SV50-7518T 20 G/0.9

Titanium Retinal Forceps

Micro Capsulorhexis Forceps

Capsulorhexis forceps 4mm long jaws with angled, grasping platform. Curved shaft 24mm long.

SV50-7651 21G/0.8 S.S

SV50-7651T 21G/0.8 titanium

SV50-7652 23G/0.6 S.S

SV50-7652T 23G/0.6 titanium



Ikeda Capsulorhexis forceps
0.6mm (23G) Delicate 1.2mm long jaws
with angled, grasping platform.

Curved shaft 24mm

SV50-7653 S.S

SV50-7653T titanium



Ikeda angled micro Capsulorhexis
0.9mm long jaw with
90° angled,
grasping platform.

Strongly curved shaft 24mm

SV50-7654 S.S

SV50-7654T titanium

23 G, MICS/MCCS Coaxial Capsulorhexis Forceps

MICS/MCCS Capsulorhexis 23G
1.3 mm jaws, for 1 mm incisions

SV50-600001T titanium



MICS capsulorhexis forceps

SV50-7655T

23G Ikeda capsulorhexis forceps 0.65 mm
delicate 1.2 mm long jaws with angled,
grasping platform, curved shaft

SV50-7656T

23G komaki micro capsulorhexis forceps
universal capsulorhexis forceps 0.7 mm
long jaws with 90° angled grasping platform

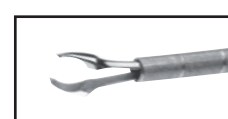

Botvin

Iris Forceps

For peripheral iridectomies.

SV50-1040 serrated tips

SV50-1050 1x2 teeth



Colibri Style

very delicate, 1x2 teeth, 0.12mm

SV50-1500 Colibri

SV50-1520 Harms-Colibri, with tying platform

SV50-1520T Harms-Colibri, titanium, with tying platform

SV50-1522 Dyson-Colibri, short tips, extremely thin shanks, with tying platform Standard, 1x2 teeth with tying platform

SV50-1550 Colibri, 0.4mm Corneal Suturing Forceps delicate, 1mm spread, 1x2 teeth, 0.12mm

SV50-1560 Polack Corneal Forceps

very delicate, 1x1 teeth, 0.1mm

SV50-1700 Pierser-Colibri



SV50-1500



SV50-1520



SV50-1522



SV50-1550



SV50-1560



SV50-1700



Gills - Colibri

Tissue Forceps

very fine pointed tips

with tying platform

SV50-1450

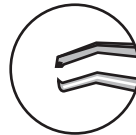

Colibri Forceps

Colibri corneal forceps,

delicate, 1x2 straight, with tying platform

SV50-118950-1 0.12 mm

SV50-118950-2 0.40 mm

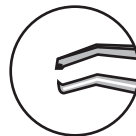

Harms

SV50-118950-3

0.12 mm teeth,

with tying 1x2 oblique

Hoskin

Tissue Forceps, straight

SV50-1718 #18, fine grooved tips

SV50-1719 #19, micro grooved tips

SV50-1728 #28, very delicate, micro grooved tips

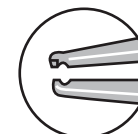

SV50-1718

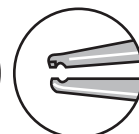

SV50-1719

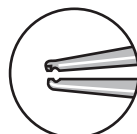

SV50-1728



Forceps

Hoskin

Tissue Forceps,
Colibri style

SV50-1722 #22, micro grooved tips

SV50-1730 #30, very delicate micro
grooved tips

SV50-1734 #34, pointed tips

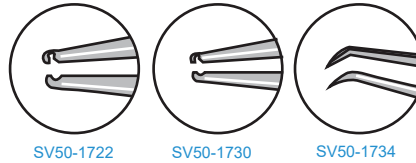

SV50-1722

SV50-1730

SV50-1734



Pierse

Corneal Forceps
very delicate 1x1 teeth,
0.1mm straight

SV50-1800

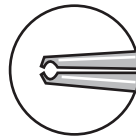

Fechtner

Conjunctiva Forceps
very delicate ring shaped
tips with tying platform

SV50-1820

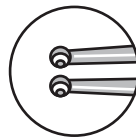

Castroviejo - Colibri

SV50-1900 1x2 teeth, 0.12mm

SV50-1902 Harms 1x2 teeth,
0.12mm with tying platform

SV50-1920 Hyde 2x2 teeth,
0.12mm with tying platform

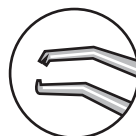

Hoskin

Tissue Forceps, curved

SV50-1716 #16, fine grooved tips



Bonn

French pattern bonn forceps 0.1 mm
with tying

- SV50-7850A 11cm long handle
- SV50-7835 7.5cm short handle
- SV50-7835T titanium



Bonn

Forceps
very delicate 1x2 teeth, 0.12mm

- SV50-2000
- SV50-2010 with tying



Bonn

Forceps
1x2 teeth, 0.12mm
with tying platform

- SV50-2020 S.S
- SV50-2020T titanium



Thorpe

Corneal Forceps
2x3 teeth, 0.12mm
with tying platform

- SV50-2100



Colibri Corneal Forceps

Colibri Corneal Forcep with
tying platform titanium

- SV50-500095T 0.10 1x2
- SV50-500095-1T 0.30 1x2



Forceps

Bonn Corneal Forceps

Bonn Corneal Forcep
delicate, 1x2 straight 0.12mm teeth
with tying platform
[SV50-500093](#)



Corneal Forceps

Corneal Forcep
delicate, 1x2 straight 0.12mm teeth
with tying platform, ergonomic handle
[SV50-500094](#)

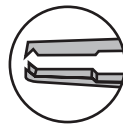

Corneal Forceps

Corneal Forcep 1x2 delicate w/tying
platform titanium ergonomic handle
[SV50-500096T](#) 0.10
[SV50-500096-1T](#) 0.30
[SV50-500096-2T](#) 0.10 oblique
[SV50-500096-3T](#) 0.30 oblique

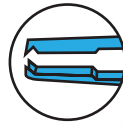

Corneal Forceps

Corneal Forceps 90mm titanium
[SV50-500097T](#) 0.12 1x2
[SV50-500097-1T](#) 0.3 1x2
[SV50-500097-2T](#) 0.12 1x2 oblique
[SV50-500098T](#) 0.3 notched
Plain tying forceps
[SV50-500098-1T](#) 5mm titanium



Kelmann McPherson

Kelmann Forcep 90mm titanium
[SV50-600009T](#) tying Ang 9mm
[SV50-600009-1T](#) tying Ang 7mm
[SV50-600009-2T](#) tying Ang 11mm



Iris forceps

Iris forceps, 1x2 straight,
0.20 mm teeth, with tying platform
[SV50-700006](#)

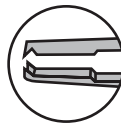

Corneal forceps

Corneal forceps, delicate, 1x2 straight
0.12 mm teeth, with tying platform
[SV50-13160](#)

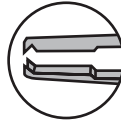

Conjunctival and Fixation Forceps

Conjunctival and fixation, forceps
1x2 straight, 0.50 mm teeth
[SV50-700008](#)

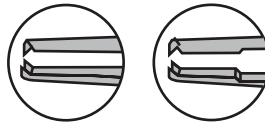

Scleral forceps, straight,
1x2 straight 0.70 mm teeth, with tying platform
[SV50-700009](#)

Conjunctival and Fixation Forceps

Conjunctival and fixation, forceps
1x2 straight, 0.50 mm teeth
[SV50-700010](#)

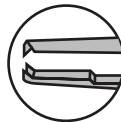

Suturing forceps

Suturing forceps, straight,
1x2 oblique teeth, with tying platform
[SV50-700011-1](#) 0.12mm
[SV50-700011-2](#) 0.35mm
[SV50-700011-3](#) 0.60mm
[SV50-700011-4](#) 0.90mm

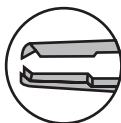

Forceps

Jayle Corneal Tying Forceps

SV50-5505 0.15mm teeth
SV50-5506 0.3mm teeth

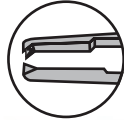

Jayle Corneal Tying Forceps

SV50-5507T 0.12mm teeth titanium
SV50-5508T 0.3mm teeth titanium

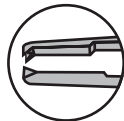

St.Martin Corneal Tying Forceps

SV50-5509
0.15mm teeth
SV50-5510
0.3mm teeth
SV50-5511T 0.15mm teeth titanium
SV50-5512T 0.3mm teeth titanium

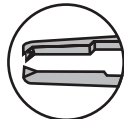
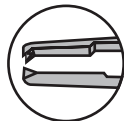

Bonn Micro Tying Forceps

SV50-5513
corneal 0.12mm teeth
SV50-5514T corneal 0.12mm teeth titanium
SV50-5515
iris 0.12mm teeth
SV50-5516T iris
0.12mm teeth titanium



Mcpherson

Tissue Forceps
1x2 teeth, 0.4mm with tying platform
SV50-2300 straight
SV50-2310 angled
8mm long 1x2 teeth, 0.3mm
SV50-2330 angled

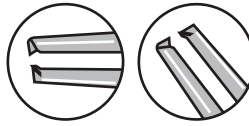

Hoffer - Mcpherson

Forceps very delicate
11mm long jaws
1x2 teeth, 0.12mm
SV50-2350



Castroviejo Suturing Forceps

1x2 teeth with tying platform
SV50-2500 0.12mm
SV50-2510 0.3mm
SV50-2520 0.5mm
SV50-2530 0.9mm
SV50-2500T 0.12mm, titanium

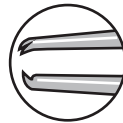

Castroviejo Suturing Forceps

1x2 teeth with tying platform
SV50-25500 0.12mm
SV50-25501 0.3mm
SV50-25502 0.5mm
SV50-25503 0.9mm
SV50-25504T 0.12mm, titanium

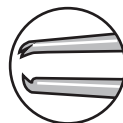

Castroviejo Suturing Forceps

1x2 teeth with tying platform
SV50-25300 0.12mm
SV50-25300-1 0.3mm
SV50-25300-2 0.5mm
SV50-25300-3 0.9mm

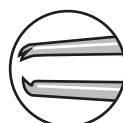

Bishop-Harmon

Tissue Forceps 1x2
teeth

SV50-3500 delicate

SV50-3510 standard

SV50-3520 heavy

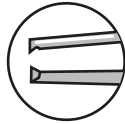

Bishop-Harmon

Dressing Forceps

SV50-3550 criss-cross serrated tips

SV50-3550-1 serrated 0.5

SV50-3550-2 serrated 0.8

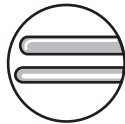

Fixation Forceps

1x2 teeth, 0.3mm

SV50-3560 sauer

SV50-3562 manhattan Eye & Ear

with tying platform



Dressing Forceps

Serrated, delicate

SV50-4000 straight

SV50-4010 curved



Tissue Forceps

1x2 teeth

SV50-4100 delicate, straight

SV50-4110 delicate, curved

SV50-4140 standard, straight

SV50-4141 standard, curved



Forceps

Adson

straight, 5" (125mm) long
[SV50-4150](#) Dressing Forceps
serrated jaws, delicate
[SV50-4152](#) Dressing Forceps
serrated jaws, standard
[SV50-4170](#) Tissue Forceps
1x2 teeth, delicate
[SV50-4172](#) Tissue Forceps,
1x2 teeth, standard

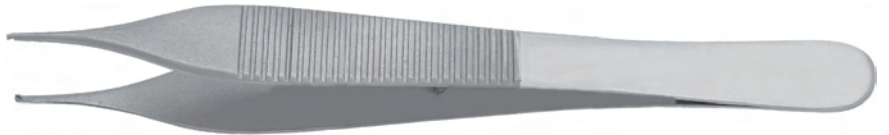
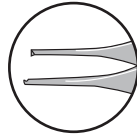

Bayonet

Dressing Forceps serrated jaws
5 3/4" (146mm) long
[SV50-4180](#)



Lester

Fixation Forceps straight
[SV50-4300](#) 1x2 teeth
[SV50-4320](#) 2x3 teeth



Fixation Forceps

1x2 teeth
[SV50-4500](#) Bracken delicate teeth
[SV50-4550](#) Elschnig, standard teeth

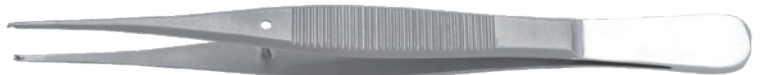

Troutman

Superior Rectus
Forceps 1x2 teeth angled
[SV50-4700](#)



Tying Forceps

For 8-0 to 11-0 sutures forceps

McPherson

SV50-5000 5mm long tying straight

SV50-5000T 5mm long tying straight, titanium

SV50-5010 5mm long tying angled

SV50-5010T angled, 5mm long tying titanium

Kelman - McPherson forceps

SV50-5030 7.5mm long tying angled

SV50-5030T 7.5mm long tying angled, titanium

Bechert Forceps

SV50-5049 10mm long tying angled

Gaskin Forceps

SV50-5050 11mm long tying angled

SV50-5050T 11mm long tying angled titanium

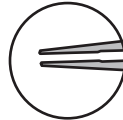

SV50-5000



SV50-5010



SV50-5030

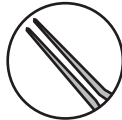

SV50-5049

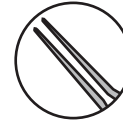

SV50-5050



Haberle-McPerson

Lens Holding Forceps

7.5mm long jaws

with groove, angled

For grasping IOL haptic

SV50-5040

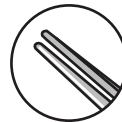

Kurstin

Flap Stretching Forceps

disc shaped

serrated jaws

Designed for stretching
the flap to eliminate striae.

SV50-5056

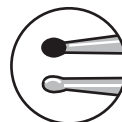

Forceps

Buratto

LASIK Flap Forceps
disc shaped
serrated jaws
[SV50-5058](#)

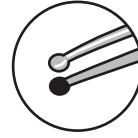

Inamura

Capsulorrhexis Forceps
delicate tapered shanks
to seal the incision during
continuous curvilinear
capsulorrhexis
Excellent for MICS
[SV50-5070](#)

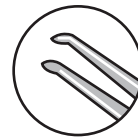

Utrata

Capsulorrhexis Forceps
very delicate, short handle
triangular grasping tips
extremely thin
with landmarks at 2.5mm and
5.0mm
[SV50-5071](#) straight



Masket

Capsulorrhexis Forceps
very delicate, short handle
triangular grasping tips
extremely thin
with landmarks at 2.5mm and
5.0mm
[SV50-5074](#) vaulted



Kraff

Capsule Tag Forceps
11mm long shanks
1.5mm long grasping tips
[SV50-5080](#)

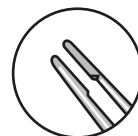

Utrata

Capsulorrhexis Forceps
very delicate
triangular grasping tips
extremely thin
11mm long shanks
[SV50-5081](#) stainless steel
[SV50-5081T](#) titanium



Utrata

Capsulorrhexis Forceps
very delicate
triangular grasping tips
extremely thin
11mm long shanks
round handle with guide pin
for alignment
[SV50-5082](#)



Nevyas

Capsulorrhexis Forceps
cystotome shaped tips
extremely thin
11mm long shanks
For tearing and grasping the
anterior capsule.
[SV50-5083](#) stainless steel
[SV50-5083T](#) titanium



Masket

Capsulorrhexis Forceps
very delicate
triangular grasping tips
extremely thin 11mm long
vaulted shanks
[SV50-5084](#)
[SV50-5084T](#) titanium



Inamura

Capsulorrhexis Forceps
round handle cross action
2 mm incision
[SV50-50070](#)

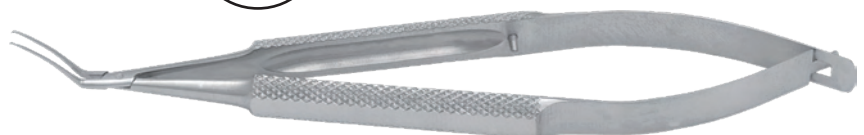

Inamura Capsulorhexis Forceps

Sharp pointed serrated tips angled 90° from shaft
Curved shaft, tip to pivot point 8.5mm
Cross action tips, 1.2mm width at pivot box
Round handle, overall length 111mm desired size of capsulorhexis

SV50-00786T

SV50-00786-1T marks on shaft at 2.5mm and 5.0mm denote

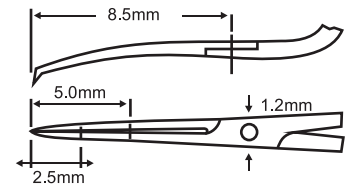

Capsulorhexis forceps

Capsulorhexis forceps, lightweight, angled, 12 mm, slightly curved arms, sharp tips,

SV50-80001234T titanium

Capsulorhexis forceps, lightweight, angled, 12 mm, slightly curved arms, strongly angled, sharp tips,

SV50-80001234-1T titanium

Capsulorhexis forceps, lightweight, angled, 11 mm, slightly curved arms, notched tips

SV50-80001234-2T titanium

Capsulorhexis forceps, lightweight, angled, 11 mm, slightly curved arms, sharp, strongly angled tips

SV50-80001234-3T titanium

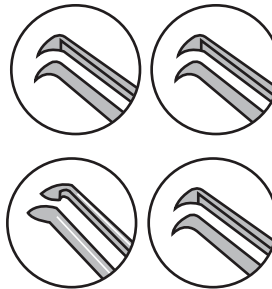

Capsulorhexis forceps

Capsulorhexis forceps, angled, 11 mm slightly curved arms, sharp, notched tips

SV50-700003



Capsulorhexis forceps

Capsulorhexis forceps, angled, 11 mm slightly curved arms, sharp tips ergonomic handle

SV50-700002T titanium



Forceps

Capsulorhexis forceps

Capsulorhexis forceps
flat handle, 11 mm sharp tips,
micro incision
SV50-700001T titanium



MICS capsulorhexis forceps

MICS capsulorhexis forceps,
controlled opening for 2 mm incisions
SV50-700018T titanium

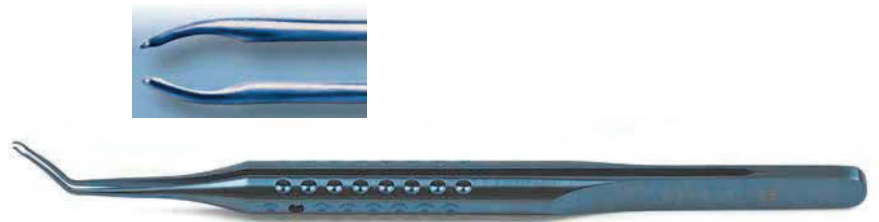

Capsulorhexis forceps for micro coaxial phaco

Capsulorhexis forceps with 2mm
controlled opening for 2mm incisions
SV50-500099T titanium



MICS/MCCS Capsulorhexis Forceps

MICS/MCCS Capsulorhexis
with 2 mm controlled opening,
for 2 mm incisions
SV50-600000



Capsulorhexis Forceps

extremely delicate
SV50-31300



Prechopper

Combo Prechopper,
for grades 1-4 nuclei,
2 mm opening, sharp top side
[SV50-600005-1](#)



Prechopper

Akahoshi Super Combo III Prechopper
For nucleus grades 1 to 3.
is suitable for the vertical Karate
Prechop technique within a 2mm incision.
Prechopping can be completed without
nuclear support for nuclei grade 1 to 3
[SV50-7233](#)

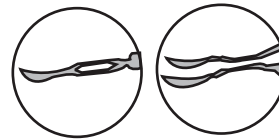

Akahoshi Hybrid Combo prechopper
For Grades 1-4 Nuclei
[SV50-7235](#)

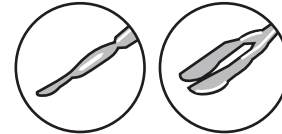

Akahoshi Universal Nucleus Splitter
[SV50-7236](#)

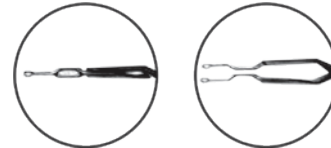

Akahoshi

Phaco PreChopper
4.5mm long delicate jaws
with sharp tips
For cracking, dividing and rotating
the nucleus without sculpting
[SV50-7230](#)



Akahoshi

Combo PreChopper
For cracking, dividing and rotating
both hard and soft nuclei without
sculpting
[SV50-7232](#)



Forceps

Anis

Tying Forceps
extra delicate
smooth jaws
For 9-0 to 11-0 sutures.
[SV50-5112](#) straight
[SV50-5113](#) curved

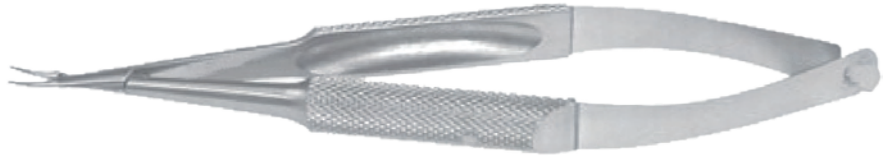

Freeman - Jaffe

Lens Holding Forceps
with longitudinal groove
For grasping IOL haptic.
[SV50-5190](#)



Jaffe

Tying Forceps
very delicate
smooth jaws
6mm long platform
For 8-0 to 11-0 sutures.
[SV50-5200](#) straight
[SV50-5210](#) curved
[SV50-5200T](#) straight titanium
[SV50-5210T](#) curved titanium

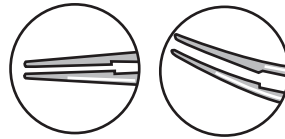

Gerl

Tying Forceps
curved shanks
6mm long platform
For 8-0 to 11-0 sutures.
[SV50-5215T](#) titanium



Tennant

Tying Forceps
extra delicate smooth jaws with
6mm long platform round handle
with guide pin For 9-0 to 11-0
sutures.
[SV50-5220](#) straight
[SV50-5220T](#) straight, titanium
[SV50-5230](#) curved
[SV50-5230T](#) curved, titanium

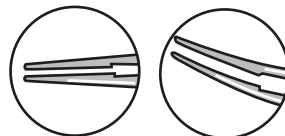

Maumenee

Tying Forceps
concave-convex jaws
round handle with guide pin
For 8-0 to 11-0 sutures.

SV50-5234T straight titanium

SV50-5235T angled titanium

SV50-5234 straight

SV50-5235 angled



Jaws Cross Section



Harms

Tying Forceps
standard, smooth jaws
for 7-0 to 9-0 sutures.

SV50-5400 straight

SV50-5410 curved

SV50-5400T straight titanium

SV50-5410T curved titanium

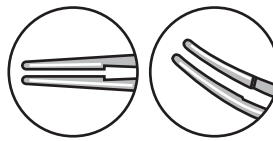

Tuebingen Model

Tying forceps straight

SV50-19030 S.S

SV50-19030T titanium

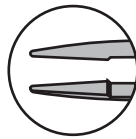

Tuebingen Model

Tying forceps curved

SV50-19040 S.S

SV50-19040T titanium

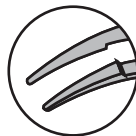

McPherson Tying Forcep

Recommended for 8-0 to 10-0 sutures

SV50-700019 4mm tying straight

SV50-700019-1 4mm tying curved

SV50-700019-2 4mm tying angled

SV50-700019-3 8mm tying angled

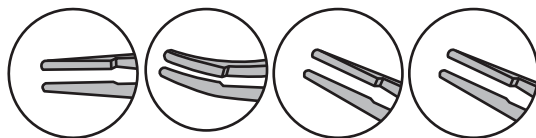

Forceps

Kelmann forcep

Kelmann forcep angled
ergonomic handle
SV50-600007 11 mm tying
SV50-600007-1 7 mm tying



Troutmann forcep

Troutmann forcep very delicate
ergonomic handle
SV50-600075 7 mm tying str
SV50-600008 7 mm tying cvd

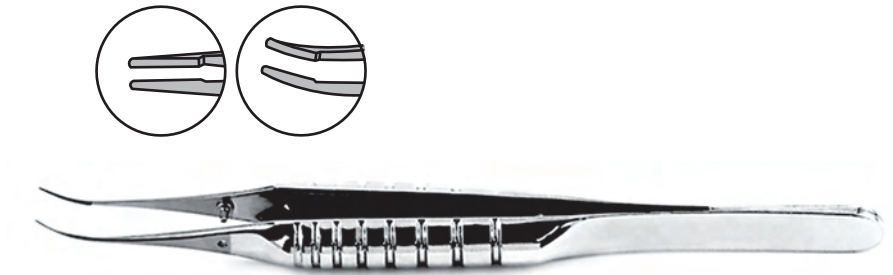

Harms Tying forcep

Harms Tying forcep curved,
with 6 mm tying platform
recommended for 8-0 to 10-0 sutures
SV50-700018



IOL Loading forceps

Loading forceps for foldable lenses
into the cartridge, 11 mm angle to tip,
cylindrical arms
SV50-700014T titanium



Golf Ball Tying Forcep

Golf ball tying forcep titanium
SV50-700016-1T angled 8mm
SV50-700016-2T straight 5mm
SV50-700016-3T curved 5mm
SV50-700016-4T delicate str 5mm

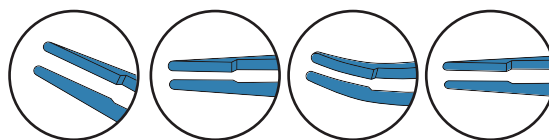

Tying Forceps

Troutman forceps 6mm
SV50-55410 straight
SV50-55420 curved

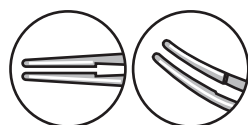

Kelman McPherson

French pattern tying forceps
11mm angled
SV50-500088

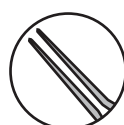

McPherson

SV50-511188 Tying Forceps 5mm str
SV50-500089 Tying Forceps 5mm angled
SV50-500090 Tying Forceps 10mm angled

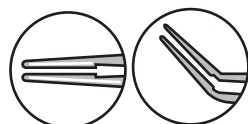

Fixation forceps

Fixation forceps, straight,
SV50-700012-1 3mm
SV50-700012-2 4mm

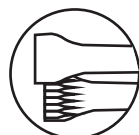

Green Fixation Forceps

Green fixation forceps
SV50-700013



Forceps

Helveston

Tying Forceps
standard, smooth jaws
For 4-0 to 6-0 sutures.
[SV50-5420](#)

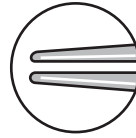

Fine

Tying Forceps
standard, smooth jaws
For 7-0 to 9-0 sutures.
[SV50-5550](#)

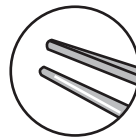

Arita

Meibomian Gland Compressor
broad, smoothly polished jaws
[SV50-5900](#)



Cilia Forceps with spring tension

[SV50-6205](#)
[SV50-6205T titanium](#)

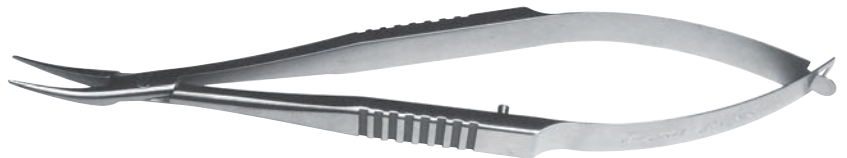

Barraquer Cilia Forceps

[SV50-6001](#)



BEER Forceps Cilia

[SV50-9300](#)



Barraquer

Cilia Forceps lightly angled
Textured jaws provide
superior grasping capabilities.
[SV50-6000](#)



Cilia Forceps

Cilia Forceps
slanted jaws gold plated
[SV50-6020](#)



Gradle

Cilia Forceps smooth jaws
[SV50-6100](#)



Bonaccolto

Conjunctiva Forceps
longitudinally serrated jaws
with cross serrations at tips
[SV50-6200](#) 1.2mm wide
[SV50-6210](#) 1.7mm wide



Giannetti

MICS Capsulorrhesis Forceps
ultra delicate shanks and tips
maximum jaw opening 1.75mm
For performing capsulorrhesis
through a micro incision.
[SV50-5090](#)



Forceps

Moorfields Conjunctival Forceps

SV50-5500F standard

SV50-5501F fine

SV50-5500FT standard titanium

SV50-5501FT fine titanium

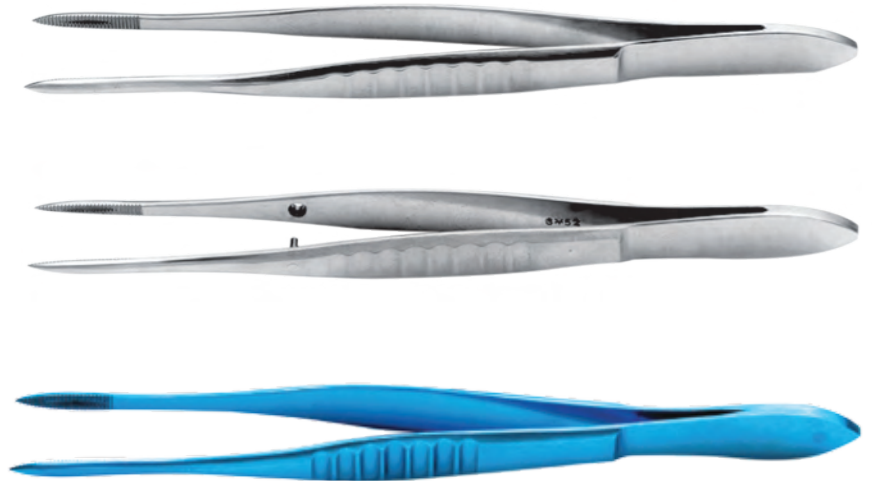

Stallard Tying Forceps

SV50-5502



Rycroft Corneal Tying Forceps

SV50-5503 plain

SV50-5504 0.3mm teeth

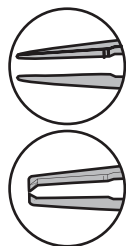

Scleral Plug Forceps

SV50-5517



Forceps

Jewelers

Forceps
standard, straight
SV50-6510 #1



Jewelers

Forceps delicate,
straight
SV50-6520 #3-C



Jewelers

Forceps
delicate, straight
SV50-6530 #3



Jewelers

Forceps
delicate, straight
SV50-6540 #4



Jewelers

Forceps
extra delicate, straight
SV50-6550 #5



Osher

Iris Forceps
very fine textured jaws
angled
SV50-6558



Jewelers

Forceps
extra delicate, angled
SV50-6560 #5/45



Jewelers

Forceps
curved
SV50-6570 #7



Suture

Removal Forceps
very fine pointed tips with textured
jaws Ideal for grasping wet sutures
SV50-6575



Jaffe

Utility Forceps
very delicate smooth jaws curved
SV50-6600



Forceps

Arruga
Capsule Forceps
[SV50-7000](#)



Rigid IOL implantation forceps
Rigid IOL implantation forceps, angled
[SV50-700015](#)



Implantation forceps
Implantation forceps
for 5.5 and 6.0 mm acrylic IOLs
[SV50-600006](#)



Ernest
Nucleus Cracker
extra delicate cross-action
serrated paddle tips
For cracking the nucleus
through a 2.5mm incision
[SV50-7240](#)



Ernest
Micro Nucleus Cracker
extra delicate cross-action
serrated paddle tips
For cracking the nucleus
through a 2mm incision.
[SV50-7242](#)



Dodick

Nucleus Cracker
cross-action
longitudinally serrated
paddle shaped jaws
For cracking the nucleus
through a 3mm incision
[SV50-7244](#)

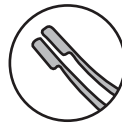

Hu Femto Forceps

Blunted 0.3mm tips
cross-action mechanism
For opening incisions
created with a
femtosecond laser
[SV50-7245](#)



Alfonso

Nucleus Grasping Forceps
two short rows of
delicate interlocking teeth
For grasping and extracting
nucleus fragments
[SV50-7253](#)



Coaxial forceps

Coaxial forceps for endothelial
lenticule insertion in DSEK technique,
atraumatic
[SV50-3839.5T](#)



Corneal-scleral punch

Corneal-scleral punch,
straight, Ø 1.5 mm Ø 1.7 mm
[SV50-2865](#)

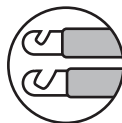

Forceps

Blaydes

Lens Holding Forceps
very delicate narrow jaws
angled 45°
[SV50-8500](#)

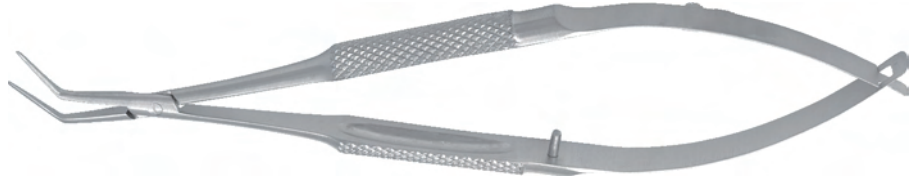

Shepard

Lens Holding Forceps
duckbill shaped jaws
gently curved
[SV50-8600](#)



Clayman

Lens Holding Forceps
delicate angled jaws
gently curved
[SV50-8700](#)



Jameson

Muscle Forceps
with slide lock
[SV50-9000](#) 4 teeth, child size, right
[SV50-9010](#) 4 teeth, child size, left
[SV50-9020](#) 6 teeth, adult size, right
[SV50-9030](#) 6 teeth, adult size, left



Berke

Ptosis Forceps
with slide lock
longitudinally grooved jaws
[SV50-9300](#) 20mm long
[SV50-9310](#) 27mm long



Forceps

Chalazion Forceps

oval

SV50-9550 Baird, 11 x 8mm I.D. small

SV50-9600 Francis, 14 x 11mm I.D. medium

SV50-9650 Desmarres, 20 x 13mm I.D. large

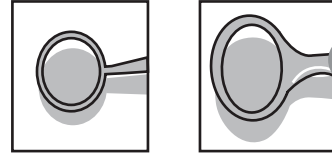

Desmarres Forceps

Oval

SV50-2125 25mm



Chalazion Forceps

round

SV50-9450 Lambert, 8mm I.D.

SV50-9500 Hunt, 12mm I.D.

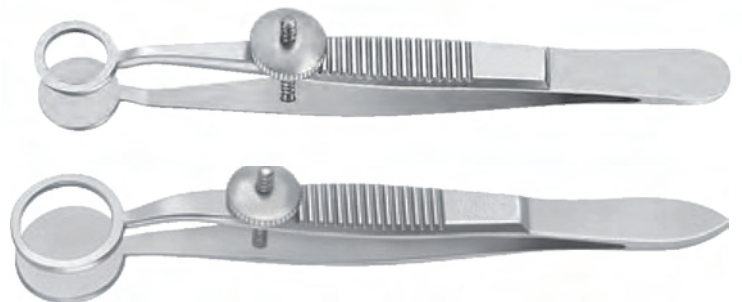

Watzke

Sleeve Spreading Forceps

SV50-7950



Hartmann

Mosquito Forceps
extra delicate
3 $\frac{3}{4}$ " (95mm) long
[SV50-9900](#) straight
[SV50-9910](#) curved



Halsted

Mosquito Forceps
delicate
5" (125mm) long
[SV50-9940](#) straight
[SV50-9950](#) curved

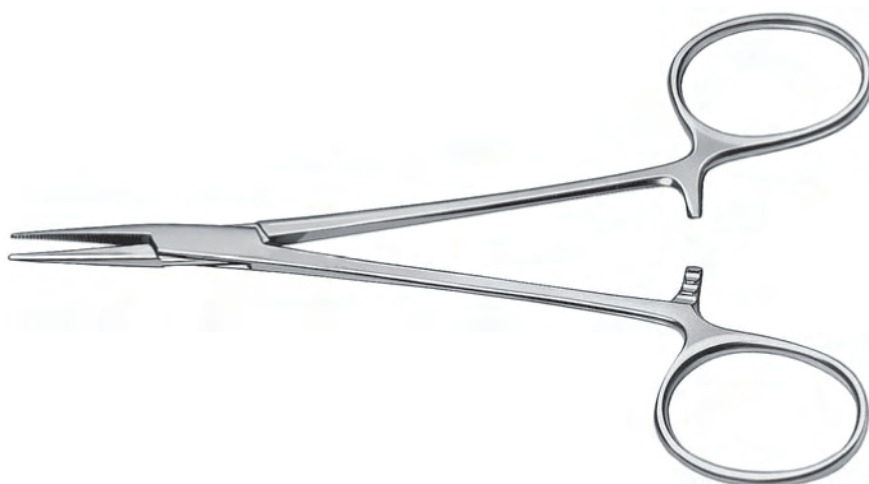

Halsted

Mosquito Forceps
delicate 1x2
5" (125mm) long
[SV50-9970](#) straight
[SV50-9980](#) curved

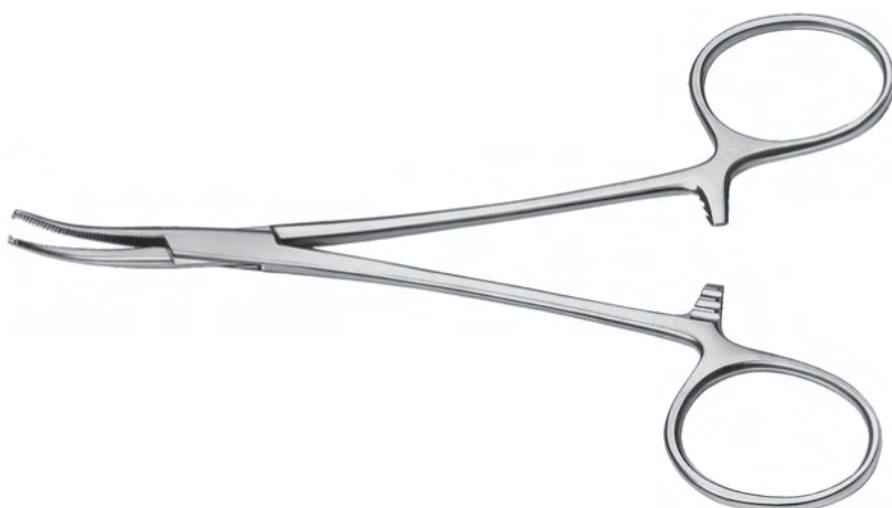

Forceps

Backhaus

Towel Clamp

SV50-9964 3½" (90mm)

SV50-9965 5¼" (135mm)

SV50-9964T 3½" (90mm) titanium

SV50-9965T 5¼" (135mm) titanium



Baby Jones

Towel Clamp

Cross Action

SV50-9960 (55mm) long



Schaedel

Towel Clamp

Cross Action

SV50-9961 (90mm) long



Serrefine

serrated jaws

SV50-9850 small (38mm)



Dieffenbach Serrefine

SV50-9851 Straight, 50 mm

SV50-9852 curved, 50 mm



Pean Forceps

Mosquito forceps,
straight, serrated jaws
[SV50-2720](#)



Ramplays Forceps

Ramplay sponge forceps
[SV50-9920](#) 18cm
[SV50-9921](#) 25cm



Frazier

Suction and wash tube,
with hole on/off, 12cm long
[SV20-1861](#)

Suction and wash tube,
with hole on/off, 17cm long
[SV20-1862](#)



SV60

- Needle Holders

McPherson

Needle Holder

very delicate jaws

SV60-1000 with lock straight

SV60-1010 without lock straight

SV60-1020 with lock curved

SV60-1030 without lock curved



Jaffe

Needle Holder

delicate conical jaws

SV60-1100 with lock straight

SV60-1120 with lock curved

SV60-1130 without lock curved



Castroviejo

Needle Holder delicate

jaws straight

SV60-1500 with lock

SV60-1510 without lock



Castroviejo

SV60-1600 with lock

SV60-1610 without lock



Silcock Needle Holder,catch

SV60-1611



Needle Holder

Castroviejo

Needle Holder delicate
jaws
curved
[SV60-1520](#) with lock
[SV60-1530](#) without lock



Castroviejo

Needle Holder
standard jaws
straight, with lock
[SV60-1560](#)
[SV60-1560TC Tungsten Tip](#)



Castroviejo

Needle Holder standard
jaws curved
[SV60-1580](#) with lock
[SV60-1581](#) without lock
[SVT60-1580](#) with lock
[SVT60-1581](#) without lock



Kalt

Needle Holder
delicate smooth jaws
straight, with lock
[SV60-1800](#)



Drews

Needle Holder
extra delicate jaws
[SV60-2990](#) straight, with lock
[SV60-2991](#) straight, without lock
[SV60-2992](#) curved, with lock
[SV60-2993](#) curved, without lock



Castroviejo

Needle Holder

delicate jaws titanium

SV60-1500T with lock str

SV60-1520T with lock cvd

SV60-1530T without lock cvd

SV60-1560T with lock standard



Barraquer

Needle Holder

short model

very delicate jaws

curved

SV60-3020 with lock

SV60-3030 without lock



Troutman

Needle Holder delicate

jaws strongly curved

SV60-3250 without lock

SV60-3260 with lock

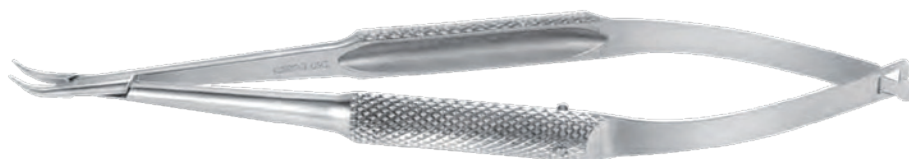

Barraquer

Needle Holder

very delicate jaws

curved

SV60-3300 with lock

SV60-3310 without lock

SV60-3300T titanium, with lock

SV60-3310T titanium, without lock



Barraquer

Needle Holder

delicate jaws straight

SV60-3500 with lock

SV60-3510 without lock



Needle Holder

Barraquer

Needle Holder
delicate jaws
curved

SV60-3520 with lock
SV60-3530 without lock

Needle Holder
delicate jaws
curved large

SV60-3540 with lock
SV60-3550 without lock



Barraquer

Needle Holder
standard jaws curved

SV60-3620 with lock
SV60-3630 without lock

SV60-3620TC Tungsten Carbide with lock
SV60-3630TC Tungsten Carbide without lock
SV60-3630T with lock titanium
SV60-3630T without lock titanium



Anis

Needle Holder
extra delicate jaws

SV60-3750 with lock straight
SV60-3751 without lock straight
SV60-3752 with lock curved
SV60-3753 without lock curved



Micro Needle Holder

Needle Holder
extra delicate jaws
straight

SV60-3800 with lock
SV60-3810 without lock
SV60-3800T titanium, with lock
SV60-3810T titanium, without lock



Barraquer (Golf Pattern)

Needle Holder
short model
very delicate jaws
Curved
SV60-1620 with lock
SV60-1630 without lock



Barraquer

Needle Holder
short model
very delicate jaws curved
SV60-1640 with lock
SV60-1650 without lock

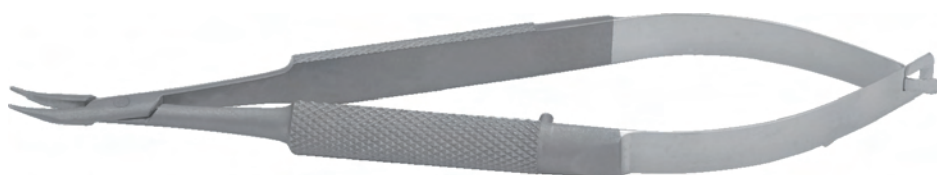

Micro Needle Holder

Needle Holder delicate
jaws straight
SV60-1660 without lock
SV60-1670 with lock



Needle Holder

delicate,
curved, without lock,
overall length: 115 mm, titanium
Ideal for 9-0 to 10-0 sutures
SV60-1680 with lock
SV60-1690 without lock
SV60-1680T titanium, with lock
SV60-1690T titanium, without lock

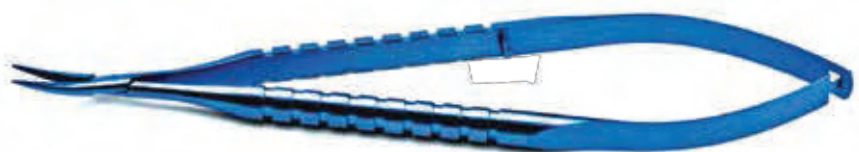

Barraquer

Needle Holder
delicate jaws
straight
SV60-1700 with lock
SV60-1710 without lock
SV60-1700 with lock, titanium
SV60-1710T without lock, titanium



SV70

- Lacrimal Instruments
- Bimanual I/A
- Quickswitch I/A System
- Infusion Handles
- Roungeurs
- Nasal Speculums
- Elevators
- Chisels
- Mallets
- Probes

Kerrison

Bone Nibbling Rongeur 9mm
opening

SV70-1800 size 0, 3.0mm wide

SV70-1801 size 1, 3.5mm wide

SV70-1802 size 2, 4.0mm wide

SV70-1803 size 3, 4.5mm wide



Citelli

Bone Nibbling Rongeur
7mm opening

2.0mm wide

SV70-1805

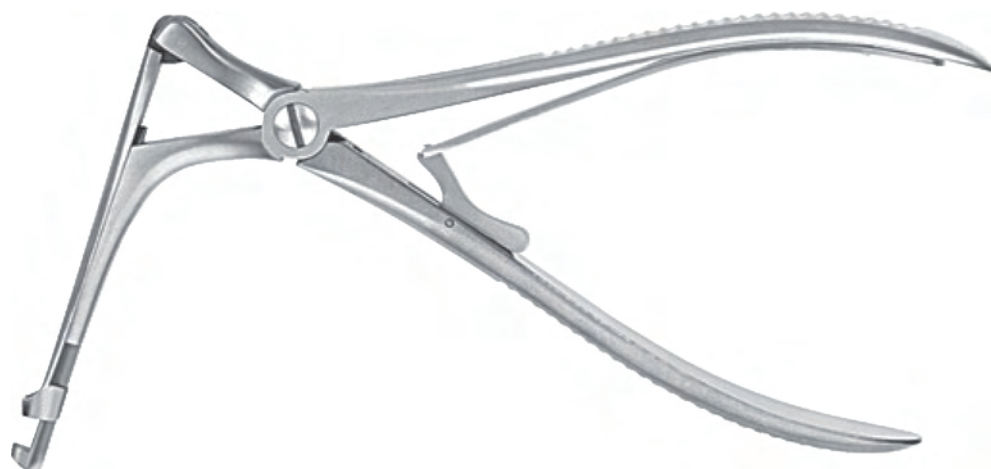

Beyer

Rongeur
single action

SV70-1810



Mallet

lead filled
stainless steel head
SV70-1860



2/3

Harms

Trabeculotomy Probe
SV70-1000 right
SV70-1010 left

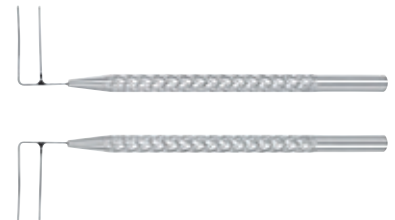

Infant

Lacrimal Dilator
very fine blunt tip
SV70-2000



Muldoon

Lacrimal Dilator
SV70-2100



Wilder

Lacrimal Dilator
SV70-2110 size 1, fine taper
SV70-2120 size 2, medium taper
SV70-2130 size 3, heavy taper



Lacrimal instruments

Castroviejo

Lacrimal Dilator
double-end
fine and
medium taper
[SV70-2300](#)



Bowman

Lacrimal Probe malleable
stainless steel
[SV70-2500](#) set of 6
[SV70-2510](#) size 0000 & 000
[SV70-2520](#) size 00 & 0
[SV70-2530](#) size 1 & 2
[SV70-2540](#) size 3 & 4
[SV70-2550](#) size 5 & 6
[SV70-2560](#) size 7 & 8

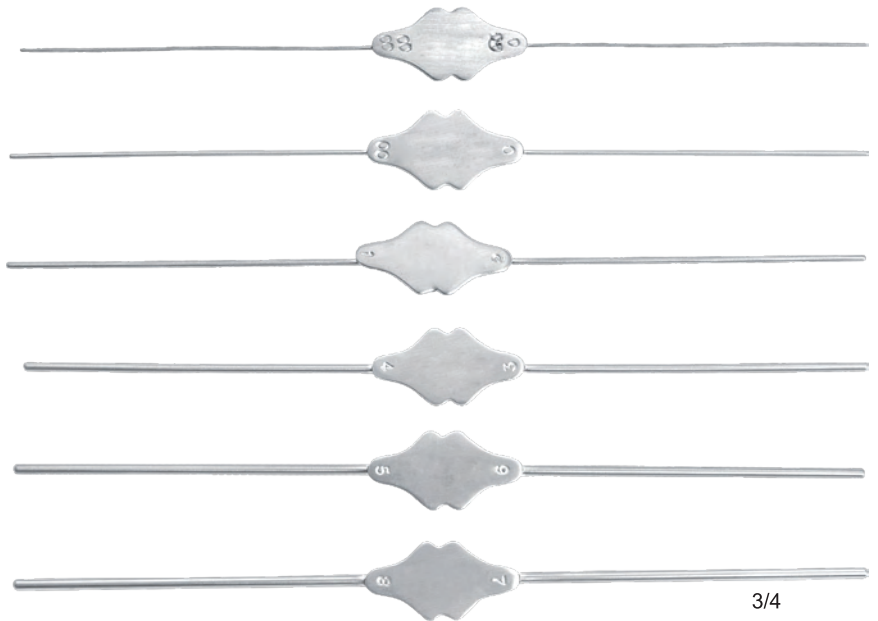

3/4

Catalano

Lacrimal Intubation Set includes
2 blunt
0.7mm diameter probes attached
to 30.5cm long silicone tubing
.012" I.D., .025" O.D.
[SV70-2610](#) set
[SV70-2602](#) silicone tubing only



3/4

Crawford

Lacrimal Intubation Set
includes 2 olive tip
0.6mm diameter probes
attached to 30.5cm long
silicone tubing
.012" I.D., .025" O.D.
[SV70-2620](#) set
[SV70-2602](#) silicone tubing only



3/4

Crawford

Retrieving Hook
for Crawford lacrimal
intubation probes
[SV70-2623](#)



Pigtail

Probe
with suture holes
[SV70-2900](#)



Rollet Rugine

[SV70-2910](#)



Nettleship Lacrimal Dilator

Nettleship lacrimal dilator
single end
[SV70-2920](#)
Nettleship lacrimal dilator
double end
[SV70-2930](#)



Howarth Periosteal Elevator

Howarth Periosteal Elevator,
for DCR, 215mm length
[SV70-2940](#)



Fison Retractor

Fison Retractor, for detachment
[SV70-2950](#)



I/A Bimanual Handles

Infusion Handle

Infusion Handle

SV70-6805 male/male connectors

SV70-6806 male/female connectors

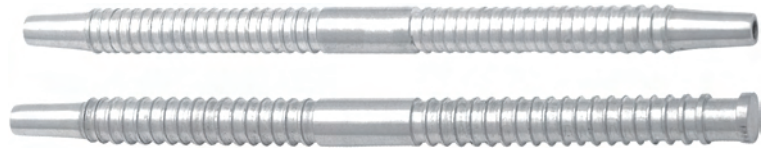

Aspiration Handpieces

with male connector
side port facing into curve
magenta color titanium

SV70-5804T 23 gauge, 0.3mm port

SV70-5805T 23 gauge, 0.3mm port, textured tip

SV70-5810T 21 gauge, 0.35mm port

SV70-5811T 21 gauge, 0.35mm port, textured tip

SV70-5814T 21 gauge, 0.4mm port

SV70-5815T 21 gauge, 0.4mm port, textured tip

SV70-5816T 22 gauge, 0.3mm port, ova

SV70-5817T 22 gauge, 0.3mm port, oval, textured tip

SV70-5822T 20 gauge, 0.3mm port, oval

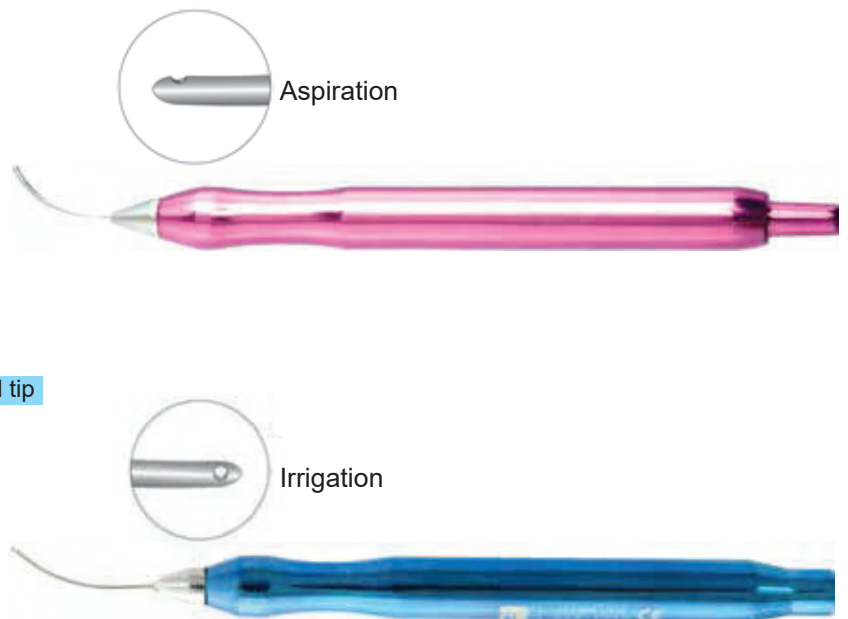

Irrigation Handpieces

with female connector, blue color

SV70-5836T 23 gauge, dual 0.3mm side ports

SV70-5838T 22 gauge, dual 0.4mm side ports, oval

SV70-5840T 21 gauge, dual 0.5mm side ports

Aspiration Handpieces Ø21G

Curved sandblasted tip

titanium handle

SV70-2233-1T



Irrigation Handpieces Ø21G

Curved tip, dual sideports,

titanium handle

SV70-2232-2T



BLUE = irrigating

Scoring Hook and Aspirating Handpiece

Scoring hook and aspirating handpiece
for DSEK procedure

SV70-2183.14T



Bipolar Forceps

Jewelers Type pointed
tips straight
SV80-7010 plain
SV80-7012 insulated



Bipolar Forceps

Bipolar Forceps
SV80-7020 Straight
SV80-7021 Angled



Bipolar

Coaptation Forceps
pointed tips
SV80-7030



Bipolar

Bayonet Forceps
SV80-7040



Bipolar Cord

Autoclavable
SV80-7065



Sterilization Tray with Lid

S.S Perforated stainless steel tray
with lid with silicon fitting
Size: 240x250x38mm
SV90-22000



Fine Mesh Trays for Micro Instruments with Silicon Mat

These trays are especially
designed for sterilizing delicate
micro instruments.

The mesh size of these trays
are 1.6mm, which helps to clean
the instruments from all directions.

- SV90-4350 160 X 70 X 20mm
- SV90-4351 160 X 100 X 20mm
- SV90-4352 200 X 125 X 20mm
- SV90-4353 200 X 150 X 20mm
- SV90-4354 265 X 160 X 20mm
- SV90-4355 210 X 190 X 20mm
- SV90-4356 250 X 250 X 20mm for Cataract Set



Fine Mesh Cassettes With Silicon Fittings For Micro Instruments

- SV90-4248 200 X 70 X 40 for 3 Micro Retinal Instruments
- SV90-4249 200 X 90 X 40 for 5 Micro Instruments
- SV90-4250 200 X 150 X 40 for 10 Micro Instruments
- SV90-4251 200 X 210 X 40 for 15 Micro Instruments



Sterilizing Cases & Trays

Micro Instruments Tray

Tray with silicone finger mat
base, lid and mat are perforated
for steam penetration

SV90-4243	for 5 instr	185x60x23mm
SV90-4244	for 10 instr	185x30x23mm
SV90-4245	for 15 instr	185x205x45mm



Ophthalmic tray

S.S Ophthalmic tray with silicon mat

SV90-35000	for 5 instruments
SV90-35000-1	for 10 instruments
SV90-35000-2	for 15 to 20 instruments



Full Perforated Tray

Tray Specially designed for small parts and burrs

SV90-4944	40 X 40 X 30mm
SV90-4945	80 X 80 X 50mm
SV90-4946	90 X 90 X 50mm

